



## **Cisco ATA 187 Analog Telephone Adaptor Administration Guide for SIP**

Version 1.0

### **Americas Headquarters**

Cisco Systems, Inc.  
170 West Tasman Drive  
San Jose, CA 95134-1706  
USA  
<http://www.cisco.com>  
Tel: 408 526-4000  
800 553-NETS (6387)  
Fax: 408 527-0883

Text Part Number: OL-21862-01

THE SPECIFICATIONS AND INFORMATION REGARDING THE PRODUCTS IN THIS MANUAL ARE SUBJECT TO CHANGE WITHOUT NOTICE. ALL STATEMENTS, INFORMATION, AND RECOMMENDATIONS IN THIS MANUAL ARE BELIEVED TO BE ACCURATE BUT ARE PRESENTED WITHOUT WARRANTY OF ANY KIND, EXPRESS OR IMPLIED. USERS MUST TAKE FULL RESPONSIBILITY FOR THEIR APPLICATION OF ANY PRODUCTS.

THE SOFTWARE LICENSE AND LIMITED WARRANTY FOR THE ACCOMPANYING PRODUCT ARE SET FORTH IN THE INFORMATION PACKET THAT SHIPPED WITH THE PRODUCT AND ARE INCORPORATED HEREIN BY THIS REFERENCE. IF YOU ARE UNABLE TO LOCATE THE SOFTWARE LICENSE OR LIMITED WARRANTY, CONTACT YOUR CISCO REPRESENTATIVE FOR A COPY.

The following information is for FCC compliance of Class A devices: This equipment has been tested and found to comply with the limits for a Class A digital device, pursuant to part 15 of the FCC rules. These limits are designed to provide reasonable protection against harmful interference when the equipment is operated in a commercial environment. This equipment generates, uses, and can radiate radio-frequency energy and, if not installed and used in accordance with the instruction manual, may cause harmful interference to radio communications. Operation of this equipment in a residential area is likely to cause harmful interference, in which case users will be required to correct the interference at their own expense.

The following information is for FCC compliance of Class B devices: The equipment described in this manual generates and may radiate radio-frequency energy. If it is not installed in accordance with Cisco's installation instructions, it may cause interference with radio and television reception. This equipment has been tested and found to comply with the limits for a Class B digital device in accordance with the specifications in part 15 of the FCC rules. These specifications are designed to provide reasonable protection against such interference in a residential installation. However, there is no guarantee that interference will not occur in a particular installation.

Modifying the equipment without Cisco's written authorization may result in the equipment no longer complying with FCC requirements for Class A or Class B digital devices. In that event, your right to use the equipment may be limited by FCC regulations, and you may be required to correct any interference to radio or television communications at your own expense.

You can determine whether your equipment is causing interference by turning it off. If the interference stops, it was probably caused by the Cisco equipment or one of its peripheral devices. If the equipment causes interference to radio or television reception, try to correct the interference by using one or more of the following measures:

- Turn the television or radio antenna until the interference stops.
- Move the equipment to one side or the other of the television or radio, or farther away from the television or radio.
- Plug the equipment into an outlet that is on a different circuit from the television or radio. (That is, make certain the equipment and the television or radio are on circuits controlled by different circuit breakers or fuses.)

Modifications to this product not authorized by Cisco Systems, Inc. could void the FCC approval and negate your authority to operate the product.

The Cisco implementation of TCP header compression is an adaptation of a program developed by the University of California, Berkeley (UCB) as part of UCB's public domain version of the UNIX operating system. All rights reserved. Copyright © 1981, Regents of the University of California.

NOTWITHSTANDING ANY OTHER WARRANTY HEREIN, ALL DOCUMENT FILES AND SOFTWARE OF THESE SUPPLIERS ARE PROVIDED "AS IS" WITH ALL FAULTS. CISCO AND THE ABOVE-NAMED SUPPLIERS DISCLAIM ALL WARRANTIES, EXPRESSED OR IMPLIED, INCLUDING, WITHOUT LIMITATION, THOSE OF MERCHANTABILITY, FITNESS FOR A PARTICULAR PURPOSE AND NONINFRINGEMENT OR ARISING FROM A COURSE OF DEALING, USAGE, OR TRADE PRACTICE.

IN NO EVENT SHALL CISCO OR ITS SUPPLIERS BE LIABLE FOR ANY INDIRECT, SPECIAL, CONSEQUENTIAL, OR INCIDENTAL DAMAGES, INCLUDING, WITHOUT LIMITATION, LOST PROFITS OR LOSS OR DAMAGE TO DATA ARISING OUT OF THE USE OR INABILITY TO USE THIS MANUAL, EVEN IF CISCO OR ITS SUPPLIERS HAVE BEEN ADVISED OF THE POSSIBILITY OF SUCH DAMAGES.

Cisco and the Cisco Logo are trademarks of Cisco Systems, Inc. and/or its affiliates in the U.S. and other countries. A listing of Cisco's trademarks can be found at [www.cisco.com/go/trademarks](http://www.cisco.com/go/trademarks). Third party trademarks mentioned are the property of their respective owners. The use of the word partner does not imply a partnership relationship between Cisco and any other company. (1005R)



The Java logo is a trademark or registered trademark of Sun Microsystems, Inc. in the U.S. or other countries.

# CONTENTS

## Preface vii

## Cisco ATA 187 Analog Telephone Adaptor Overview 1-1

|   |     |
|---|-----|
| Session Initiation Protocol Overview    | 1-2 |
| SIP Capabilities                        | 1-2 |
| Components of SIP                       | 1-3 |
| SIP Clients                             | 1-4 |
| SIP Servers                             | 1-4 |
| Hardware Overview                       | 1-5 |
| Software Features                       | 1-5 |
| Secure Real-Time Transport Protocol     | 1-6 |
| Name Signaling Event based passthrough  | 1-6 |
| Transport Layer Security Protocol       | 1-6 |
| T.38 Fax Relay                          | 1-6 |
| Voice Codecs Supported                  | 1-6 |
| Other Supported Protocols               | 1-6 |
| ATA 187 SIP Services                    | 1-7 |
| Modem Standards                         | 1-7 |
| Fax Services                            | 1-8 |
| Methods Supported                       | 1-8 |
| Supplementary Services                  | 1-9 |
| Installation and Configuration Overview | 1-9 |

## Preparing to Install the ATA 187 on Your Network 2-1

|   |     |
|---|-----|
| Understanding Interactions with Other Cisco Unified IP Communications Products    | 2-1 |
| Understanding How the ATA 187 Interacts with Cisco Unified Communications Manager | 2-2 |
| Providing Power to the ATA 187  | 2-2 |
| Power Guidelines  | 2-2 |
| Power Outage  | 2-2 |
| Understanding Phone Configuration Files   | 2-3 |
| Understanding the ATA 187 Startup Process   | 2-4 |
| Adding the ATA 187 to the Cisco Unified Communications Manager Database           | 2-5 |
| Adding the ATA 187 with Auto-Registration   | 2-6 |
| Adding the ATA 187 with Cisco Unified Communications Manager Administration       | 2-6 |
| Determining the MAC Address of an ATA 187   | 2-7 |

**Installing the ATA 187 3-1**

- Network Requirements 3-1
- Safety Recommendations 3-2
- What the ATA 187 Package Includes 3-2
- Installing the ATA 187 3-3
- Attaching a Phone to the ATA 187 3-3
- Verifying the ATA 187 Startup Process 3-3
- Configuring Startup Network Settings 3-4
- Configuring Security on the ATA 187 3-4

**Configuring the ATA 187 4-1**

- Telephony Features Available for the ATA 187 4-1
- Configuring Product Specific Configuration Parameters 4-5
- Adding Users to Cisco Unified Communications Manager 4-6

**Configuring Fax Services 5-1**

- Using Fax Mode 5-1
  - Fax Modem Standards 5-1
  - Fax Modem Speeds 5-2

**Troubleshooting and Maintenance 6-1**

- Resolving Startup Problems 6-1
  - Symptom: The ATA 187 Does Not Go Through its Normal Startup Process 6-1
  - Symptom: The ATA 187 Does Not Register with Cisco Unified Communications Manager 6-2
    - Checking Network Connectivity 6-2
    - Verifying TFTP Server Settings 6-2
    - Verifying DNS Settings 6-3
    - Verifying Cisco Unified Communications Manager Settings 6-3
    - Cisco Unified Communications Manager and TFTP Services Are Not Running 6-3
    - Creating a New Configuration File 6-3
    - Registering the Phone with Cisco Unified Communications Manager 6-4
  - Symptom: ATA 187 Unable to Obtain IP Address 6-4
- ATA 187 Resets Unexpectedly 6-5
  - Verifying Physical Connection 6-5
  - Identifying Intermittent Network Outages 6-5
  - Verifying DHCP Settings 6-5

|  |            |
|--|------------|
| Checking Static IP Address Settings                  | 6-6        |
| Verifying Voice VLAN Configuration                   | 6-6        |
| Eliminating DNS or Other Connectivity Errors         | 6-6        |
| Checking Power Connection                            | 6-7        |
| Troubleshooting ATA 187 Security                     | 6-7        |
| General Troubleshooting Tips                         | 6-7        |
| Where to Go for More Troubleshooting Information     | 6-9        |
| Cleaning the ATA 187                                 | 6-10       |
| <b>Using SIP Supplementary Services</b>              | <b>7-1</b> |
| Common Supplementary Services                        | 7-1        |
| Attended Transfer                                    | 7-2        |
| Call Pickup  | 7-2        |
| Caller ID  | 7-2        |
| Call-Waiting Caller ID                               | 7-2        |
| Call Hold  | 7-2        |
| Group Call Pickup                                    | 7-3        |
| Meet–Me Conference                                   | 7-3        |
| Privacy  | 7-3        |
| Shared Line  | 7-3        |
| Speed Dial   | 7-4        |
| Redial   | 7-4        |
| Unattended Transfer                                  | 7-4        |
| Semi-unattended Transfer                             | 7-4        |
| Fully Unattended Transfer                            | 7-5        |
| Voice Mail Indication                                | 7-5        |
| Voice-Messaging System                               | 7-5        |
| Making a Conference Call in the United States        | 7-5        |
| Making a Conference Call in Sweden                   | 7-6        |
| Call Waiting in the United States                    | 7-6        |
| Call Waiting in Sweden                               | 7-6        |
| About Call Forwarding                                | 7-6        |
| Call Forwarding in the United States                 | 7-7        |
| Call Forwarding in Sweden                            | 7-7        |
| <b>Voice Menu Codes</b>                              | <b>8-1</b> |
| Accessing the IVR and Configuring Your Phone Setting | 8-1        |

- ATA 187 Specifications** A-1
  - Physical Specifications A-1
  - Electrical Specifications A-2
  - Environmental Specifications A-2
  - Physical Interfaces A-2
  - Ringing Characteristics A-3
  - Software Specifications A-3
  - SIP Compliance Reference Information A-4
- Recommended ATA 187 Tone Parameter Values by Country** B-1

---

**GLOSSARY**

---

**INDEX**



## Preface

---

### Overview

The *Cisco Analog Telephone Adapter 187 Administration Guide for SIP (Version 1.0)* provides the information you need to install, configure, and manage the Cisco ATA 187 Analog Telephone Adapter (ATA 187) on a Session Initiation Protocol (SIP) network.

### Audience

This guide is intended for service providers and network administrators who administer Voice over IP (VoIP) services using the ATA 187. Most of the tasks described in this guide are not intended for end users of the ATA 187. Many of these tasks impact the ability of the ATA 187 to function on the network, and require an understanding of IP networking and telephony concepts.

### Organization

This manual is organized as follows:

|   |   |
|---|---|
| <a href="#">Chapter 1, “Cisco ATA 187 Analog Telephone Adapter Overview”</a>  | Provides descriptions of hardware and software features of the ATA 187 along with a brief overview of the Session Initiation Protocol (SIP).                              |
| <a href="#">Chapter 2, “Preparing to Install the ATA 187 on Your Network”</a> | Provides information on the interactions between the ATA 187, Cisco Unified Communications Manager and other devices. It also describes options for powering the ATA 187. |
| <a href="#">Chapter 3, “Installing the ATA 187”</a>                           | Provides information on how to connect the ATA 187 hardware and load the QED and firmware files.  |
| <a href="#">Chapter 4, “Configuring the ATA 187 for SIP”</a>                  | Provides information on how to configure the ATA 187 to operate with Session Initiation Protocol (SIP).   |

|  |  |
|--|--|
| Chapter 5, “Configuring and Debugging Fax Services”                | Provides instructions for configuring both ports of the ATA 187 to support fax transmission. |
| Chapter 6, “Troubleshooting and Maintenance”                       | Provides basic testing and troubleshooting procedures for the ATA 187.                       |
| Chapter 7, “Using SIP Supplementary Services”                      | Provides end-user information about pre-call and mid-call services.                          |
| Chapter 8, “Voice Menu Codes”                                      | Provides a quick-reference list of the voice configuration menu options for the ATA 187.     |
| Appendix A, “ATA 187 Specifications”                               | Provides physical specifications for the ATA 187.  |
| Appendix B, “SIP Call Flows”                                       | Provides ATA 187 call flows for SIP scenarios.   |
| Appendix C, “Recommended ATA 187 Tone Parameter Values by Country” | Provides tone parameters for various countries.  |
| Glossary   | Provides definitions of commonly used terms.   |
| Index  | Provides reference information.  |

## Related Documentation

For more information about the ATA 187 or Cisco Unified Communications Manager, refer to the following publications:

### Cisco ATA 187 Analog Telephone Adapter

- RFC 3261 (*SIP: Session Initiation Protocol*)
- RFC 2543 (*SIP: Session Initiation Protocol*)
- *Cisco ATA SIP Compliance Reference Information*  
<http://www-vnt.cisco.com/SPUniv/SIP/documents/CiscoATASIPComplianceRef.pdf>
- RFC 768 (*User Datagram Protocol*)
- RFC 2198 (*RTP Payload for Redundant Audio Data*)
- RFC 2833 (*RTP Payload for DTMF Digits, Telephony Phones and Telephony Signals*)
- RFC 2327 (*SDP: Session Description Protocol*)
- RFC 4730 (*A Session Initiation Protocol (SIP) Event Package for Key Press Stimulus (KPML)*)
- RFC 3515 (*The Session Initiation Protocol (SIP) Refer Method*)
- *Read Me First - ATA Boot Load Information*
- *Cisco ATA 187 Analog Telephone Adapter At a Glance*
- *Regulatory Compliance and Safety Information for the Cisco ATA 187*
- *Cisco ATA 187 Analog Telephone Adaptor Release Notes*

### Cisco Unified Communications Manager

These publications are available at the following URL:

[http://www.cisco.com/en/US/products/sw/voicesw/ps556/tsd\\_products\\_support\\_series\\_home.html](http://www.cisco.com/en/US/products/sw/voicesw/ps556/tsd_products_support_series_home.html)



**Cisco Unified Communications Manager Business Edition**

These publications are available at the following URL:

[http://www.cisco.com/en/US/products/ps7273/tsd\\_products\\_support\\_series\\_home.html](http://www.cisco.com/en/US/products/ps7273/tsd_products_support_series_home.html)

## Obtaining Documentation, Obtaining Support, and Security Guidelines

For information on obtaining documentation, obtaining support, providing documentation feedback, security guidelines, and also recommended aliases and general Cisco documents, see the monthly What's New in Cisco Product Documentation, which also lists all new and revised Cisco technical documentation, at:

<http://www.cisco.com/en/US/docs/general/whatsnew/whatsnew.html>

## Cisco Product Security Overview

This product contains cryptographic features and is subject to United States and local country laws governing import, export, transfer and use. Delivery of Cisco cryptographic products does not imply third-party authority to import, export, distribute or use encryption. Importers, exporters, distributors and users are responsible for compliance with U.S. and local country laws. By using this product you agree to comply with applicable laws and regulations. If you are unable to comply with U.S. and local laws, return this product immediately.

Further information regarding U.S. export regulations may be found at

[http://www.access.gpo.gov/bis/ear/ear\\_data.html](http://www.access.gpo.gov/bis/ear/ear_data.html).

## Document Conventions

This document uses the following conventions:

| Convention                  | Description   |
|-----------------------------|---|
| <b>boldface font</b>        | Commands and keywords are in <b>boldface</b> .  |
| <i>italic font</i>          | Arguments for which you supply values are in <i>italics</i> .   |
| [ ]                         | Elements in square brackets are optional.   |
| { x   y   z }               | Alternative keywords are grouped in braces and separated by vertical bars.  |
| [ x   y   z ]               | Optional alternative keywords are grouped in brackets and separated by vertical bars.                                       |
| string                      | A nonquoted set of characters. Do not use quotation marks around the string or the string will include the quotation marks. |
| screen font                 | Terminal sessions and information the system displays are in <code>screen font</code> .                                     |
| <b>boldface screen font</b> | Information you must enter is in <b>boldface screen font</b> .  |
| <i>italic screen font</i>   | Arguments for which you supply values are in <i>italic screen font</i> .  |

| Convention | Description  |
|------------|--|
| ^          | The symbol ^ represents the key labeled Control—for example, the key combination ^D in a screen display means hold down the Control key while you press the D key. |
| < >        | Nonprinting characters, such as passwords are in angle brackets.   |

**Note**

Means *reader take note*. Notes contain helpful suggestions or references to material not covered in the publication.

**Caution**

Means *reader be careful*. In this situation, you might do something that could result in equipment damage or loss of data.

**Warning**

**Means danger. You are in a situation that could cause bodily injury. Before you work on any equipment, be aware of the hazards involved with electrical circuitry and be familiar with standard practices for preventing accidents.**



# CHAPTER 1

## Cisco ATA 187 Analog Telephone Adaptor Overview

---

This section describes the hardware and software features of the Cisco ATA 187 Analog Telephone Adaptor (ATA 187) and includes a brief overview of the Session Initiation Protocol (SIP).

The ATA 187 analog telephone adaptors are handset-to-Ethernet adaptors that allow regular analog phones to operate on IP-based telephony networks. The ATA 187 support two voice ports, each with an independent phone number. The ATA 187 also has an RJ-45 10/100BASE-T data port.

This section covers these topics:

- [Session Initiation Protocol Overview, page 1-2](#)
- [Hardware Overview, page 1-5](#)
- [Software Features, page 1-5](#)
- [Installation and Configuration Overview, page 1-9](#)

**Figure 1-1** Cisco Analog Telephone Adaptor



197044

The ATA187, which operates with Cisco voice-packet gateways, makes use of broadband pipes that are deployed through a digital subscriber line (DSL), fixed wireless-cable modem, and other Ethernet connections.

**Figure 1-2** ATA 187 as Endpoint in SIP Network

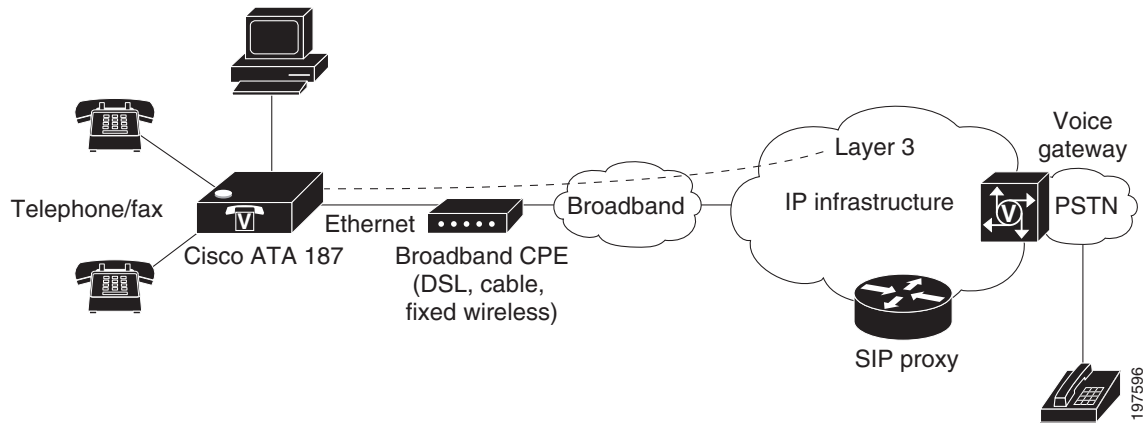

## Session Initiation Protocol Overview

Session Initiation Protocol (SIP) is the Internet Engineering Task Force (IETF) standard for real-time calls and conferencing over Internet Protocol (IP). SIP is an ASCII-based, application-layer control protocol (defined in RFC3261) that can be used to establish, maintain, and terminate multimedia sessions or calls between two or more endpoints.

Like other Voice over IP (VoIP) protocols, SIP is designed to address the functions of signaling and session management within a packet telephony network. Signaling allows call information to be carried across network boundaries. Session management provides the ability to control the attributes of an end-to-end call.



**Note** SIP for the ATA 187 is compliant with RFC2543.

This section contains these topics:

- [SIP Capabilities, page 1-2](#)
- [Components of SIP, page 1-3](#)

## SIP Capabilities

SIP provides these capabilities:

- Determines the availability of the target endpoint. If a call cannot be completed because the target endpoint is unavailable, SIP determines whether the called party is already on the phone or did not answer in the allotted number of rings. SIP then returns a message indicating why the target endpoint was unavailable.
- Determines the location of the target endpoint. SIP supports address resolution, name mapping, and call redirection.

- Determines the media capabilities of the target endpoint. Using the Session Description Protocol (SDP), SIP determines the lowest level of common services between endpoints. Conferences are established using only the media capabilities that are supported by all endpoints.
- Establishes a session between the originating and target endpoint. If the call can be completed, SIP establishes a session between the endpoints. SIP also supports mid-call changes, such as adding another endpoint to the conference or changing the media characteristic or codec.
- Handles the transfer and termination of calls. SIP supports the transfer of calls from one endpoint to another. During a call transfer, SIP establishes a session between the transferee and a new endpoint (specified by the transferring party) and terminates the session between the transferee and the transferring party. At the end of a call, SIP terminates the sessions between all parties. Conferences can consist of two or more users and can be established using multicast or multiple unicast sessions.

## Components of SIP

SIP is a peer-to-peer protocol. The peers in a session are called User Agents (UAs). A user agent can function in one of these roles:

- User agent client (UAC)—A client application that initiates the SIP request.
- User agent server (UAS)—A server application that contacts the user when a SIP request is received and returns a response on behalf of the user.

Typically, a SIP endpoint is capable of functioning as both a UAC and a UAS, but functions only as one or the other per transaction. Whether the endpoint functions as a UAC or a UAS depends on the UA that initiated the request.

From an architectural standpoint, the physical components of a SIP network can also be grouped into two categories—Clients and servers. [Figure 1-3](#) illustrates the architecture of a SIP network.



### Note

---

SIP servers can interact with other application services, such as Lightweight Directory Access Protocol (LDAP) servers, a database application, or an extensible markup language (XML) application. These application services provide back-end services such as directory, authentication, and billable services.

---

Figure 1-3 SIP Architecture

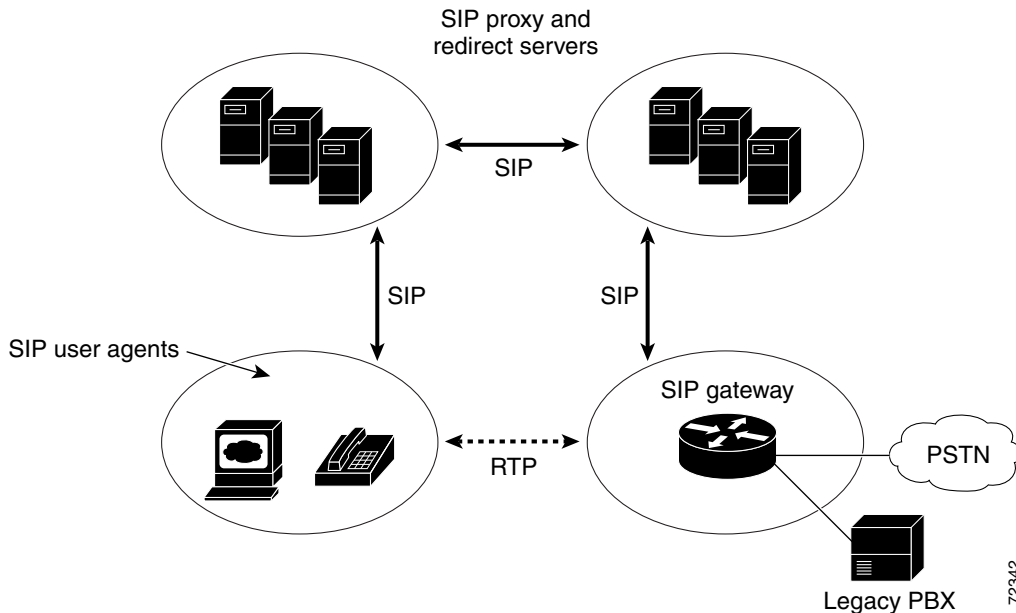

## SIP Clients

SIP clients include:

- Gateways—Provide call control. Gateways provide many services, the most common being a translation function between SIP conferencing endpoints and other terminal types. This function includes translation between transmission formats and between communications procedures. In addition, the gateway also translates between audio and video codecs and performs call setup and clearing on both the LAN side and the switched-circuit network side.
- Phones—Can act as either a UAS or UAC. The ATA 187 can initiate SIP requests and respond to requests.

## SIP Servers

SIP servers include:

- Proxy server—The proxy server is an intermediate device that receives SIP requests from a client and then forwards the requests on the client's behalf. Proxy servers receive SIP messages and forward them to the next SIP server in the network. Proxy servers can provide functions such as authentication, authorization, network access control, routing, reliable request retransmission, and security.
- Redirect server—Receives SIP requests, strips out the address in the request, checks its address tables for any other addresses that may be mapped to the address in the request, and then returns the results of the address mapping to the client. Redirect servers provide the client with information about the next hop or hops that a message should take, then the client contacts the next hop server or UAS directly.
- Registrar server—Processes requests from UACs for registration of their current location. Registrar servers are often co-located with a redirect or proxy server.

# Hardware Overview

The ATA 187 is a compact, easy to install device. [Figure 1-4](#) shows the rear panel of the ATA 187.

**Figure 1-4**      **ATA 187—Rear View**

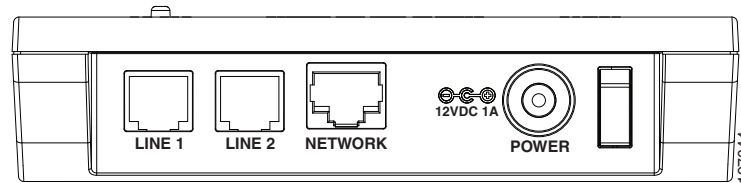

The unit provides these connectors and indicators:

- 12Vb power connector.
- Two RJ-11 FXS (Foreign Exchange Station) ports—The ATA 187 supports two independent RJ-11 phone ports that can connect to any standard analog phone device. Each port supports either voice calls or fax sessions, and both ports can be used simultaneously.
- The ATA 187 has one network port—an RJ-45 10/100BASE-T data port to connect an Ethernet-capable device, such as a computer, to the network.



The ATA 187 performs auto-negotiation for duplexity and speed and is capable of 10/100 Mbps, full-duplex operation.

## Software Features

The ATA 187 supports these protocols, services and methods:

- [Secure Real-Time Transport Protocol, page 1-6](#)
- [Name Signaling Event based passthrough, page 1-6](#)
- [Transport Layer Security Protocol, page 1-6](#)
- [T.38 Fax Relay, page 1-6](#)
- [Voice Codecs Supported, page 1-6](#)
- [Other Supported Protocols, page 1-6](#)
- [ATA 187 SIP Services, page 1-7](#)
- [Modem Standards, page 1-7](#)
- [Fax Services, page 1-8](#)
- [Methods Supported, page 1-8](#)
- [Supplementary Services, page 1-9](#)

## Secure Real-Time Transport Protocol

Secure Real-Time Transport Protocol secures voice conversations on the network and provides protection against replay attacks.

## Name Signaling Event based passthrough

Name Signaling Event (NSE)-based passthrough is simply the transport of fax or modem communications using the G.711 codec.

The ATA 187 does not support NSE-based modem passthrough.

## Transport Layer Security Protocol

Transport Layer Security (TLS) is a cryptographic protocol that secures data communications such as e-mail on the Internet. TLS is functionally equivalent to Secure Sockets Layer (SSL).

## T.38 Fax Relay

The T.38 fax relay feature enables devices to use fax machines to send files over the IP network. In general, when a fax is received, it is converted to an image, sent to the T.38 fax device, and converted back to an analog fax signal. T.38 fax relays configured with voice gateways decode or demodulate the fax signals before they are transported over IP. With the SIP call control protocol, the T.38 fax relay is indicated by Security Description (SDP) entries in the initial SIP INVITE message. After the initial SIP INVITE message, the call is established to switch from voice mode to T.38 mode. Cisco Unified Communications Administration allows you to configure a SIP profile that supports T.38 fax communication.

## Voice Codecs Supported

The ATA 187 supports these voice codecs (check your other network devices for the codecs they support):

- G.711 $\mu$ -law
- G.711A-law
- G.729A
- G.729B
- G.729AB

## Other Supported Protocols

The ATA 187 supports these additional protocols:

- 802.1Q VLAN tagging
- Cisco Discovery Protocol (CDP)



- Domain Name System (DNS)
- Dynamic Host Configuration Protocol (DHCP)
- Internet Control Message Protocol (ICMP)
- Internet Protocol (IP)
- Real-Time Transport Protocol (RTP)
- Transmission Control Protocol (TCP)
- Trivial File Transfer Protocol (TFTP)
- User Datagram Protocol (UDP)

## ATA 187 SIP Services

These services include these features:

- IP address assignment—DHCP-provided or statically configured
- ATA 187 configuration by Cisco Unified Communications Manager configuration interface
- VLAN configuration
- Cisco Discovery Protocol (CDP)
- Low-bit-rate codec selection
- User authentication
- Configurable tones (dial tone, busy tone, alert tone, reorder tone, call waiting tone)
- Dial plans
- SIP proxy server redundancy
- Privacy features
- User-configurable, call waiting, permanent default setting
- Comfort noise during silent period when using G.711
- Advanced audio mode
- Caller ID format
- Ring cadence format
- Silence suppression
- Hookflash detection timing configuration
- Configurable onhook delay
- Type of Service (ToS) configuration for audio and signaling ethernet packets
- Debugging and diagnostic tools

## Modem Standards

The ATA 187 supports the following modem standards:

- V.90
- V.92

- V.44
- K56Flex
- ITU-T V.34 Annex 12
- ITU-T V.34
- V.32bis
- V.32
- V.21
- V.22
- V.23

## Fax Services

The ATA 187 supports two modes of fax services, in which fax signals are transmitted using the G.711 codec:

- Fax pass-through mode—Receiver-side Called Station Identification (CED) tone detection with automatic G.711A-law or G.711 $\mu$ -law switching.
- T.38 Fax Relay mode: The T.38 fax relay feature enables devices to use fax machines to send files over the IP network. In general, when a fax is received, it is converted to an image, sent to the T.38 fax device, and converted back to an analog fax signal. T.38 fax relays configured with voice gateways decode or demodulate the fax signals before they are transported over IP.

**Note**

---

Success of fax transmission depends on network conditions and fax modem response to these conditions. The network must have reasonably low network jitter, network delay, and packet loss rate.

---

## Methods Supported

The ATA 187 supports these methods. For more information, see RFC3261 (*SIP: Session Initiation Protocol*).

- REGISTER
- REFER
- INVITE
- BYE
- CANCEL
- NOTIFY
- OPTIONS
- ACK
- SUBSCRIBE

## Supplementary Services

SIP supplementary services are services that you can use to enhance your phone service. For information on how to use these services, see [Chapter 7, “Using SIP Supplementary Services”](#).

The ATA 187 supports these SIP supplementary services:

- Caller ID
- Call-waiting caller ID
- Voice mail indication
- Making a conference call
- Call waiting
- Call forwarding
- Calling-line identification
- Unattended transfer
- Attended transfer
- Shared Line
- SpeedDial
- MeetMe
- Pick Up
- Redial

## Installation and Configuration Overview

[Table 1-1](#) provides the basic steps required to install and configure the ATA 187 to make it operational in a typical SIP environment where a large number of ATA 187s must be deployed.

**Table 1-1** *Overview of the Steps Required to Install and Configure the ATA 187 and Make it Operational*

| Action  | Reference  |
|---|--|
| 1. Plan the network and ATA 187 configuration.              |  |
| 2. Install the Ethernet connection.                         |  |
| 3. Install and configure the other network devices.         |  |
| 4. Install the ATA 187 but do not power up the ATA 187 yet. | <a href="#">Installing the ATA 187, page 3-3</a> |
| 5. Power up the ATA 187.                                    |  |





## CHAPTER 2

# Preparing to Install the ATA 187 on Your Network

---

The ATA 187 enables you to communicate using voice over a data network. To provide this capability, the ATA 187 depends upon and interacts with several other key Cisco Unified IP Telephony and network components, including Cisco Unified Communications Manager, DNS and DHCP servers, TFTP servers, media resources, and so on.

This chapter focuses on the interactions between the ATA 187, Cisco Unified Communications Manager, DNS and DHCP servers, TFTP servers, and switches. It also describes options for powering the ATA 187.

For related information about voice and IP communications, see this URL:

<http://www.cisco.com/en/US/products/sw/voicesw/index.html>

This chapter provides an overview of the interaction between the ATA 187 and other key components of the Voice over IP (VoIP) network. It includes these topics:

- [Understanding Interactions with Other Cisco Unified IP Communications Products, page 2-1](#)
- [Providing Power to the ATA 187, page 2-2](#)
- [Understanding Phone Configuration Files, page 2-3](#)
- [Understanding the ATA 187 Startup Process, page 2-4](#)
- [Adding the ATA 187 to the Cisco Unified Communications Manager Database, page 2-5](#)
- [Determining the MAC Address of an ATA 187, page 2-7](#)

## Understanding Interactions with Other Cisco Unified IP Communications Products

To function in the IP telephony network, the ATA 187 must be connected to a networking device, such as a Cisco Catalyst switch. You must also register the ATA 187 with a Cisco Unified Communications Manager system before sending and receiving calls.

This section includes information on [Understanding How the ATA 187 Interacts with Cisco Unified Communications Manager, page 2-2](#).

## Understanding How the ATA 187 Interacts with Cisco Unified Communications Manager

Cisco Unified Communications Manager is an open and industry-standard call processing system. Cisco Unified Communications Manager software sets up and tears down calls between phones connected to the ATA 187, integrating traditional PBX functionality with the corporate IP network. Cisco Unified Communications Manager manages the components of the IP telephony system—the phones, the access gateways, and the resources necessary for features such as call conferencing and route planning. Cisco Unified Communications Manager also provides:

- Firmware for devices
- Authentication and encryption (if configured for the telephony system)
- Configuration and CTL files via the TFTP service
- Phone registration
- Call preservation, so that a media session continues if signaling is lost between the primary Communications Manager and a phone

For information about configuring Cisco Unified Communications Manager to work with the IP devices described in this chapter, see *Cisco Unified Communications Manager Administration Guide*, *Cisco Unified Communications Manager System Guide*, and *Cisco Unified Communications Manager Security Guide*.

## Providing Power to the ATA 187

The ATA 187 is powered with external power. External power is provided through a separate power supply.

The following sections provide more information about powering a ATA 187:

- [Power Guidelines, page 2-2](#)
- [Power Outage, page 2-2](#)
- [Understanding Phone Configuration Files, page 2-3](#)

### Power Guidelines

The following power type and guideline applies to external power for the ATA 187:

- Power Type—External power (Provided through the Universal AC external power supply)
- Guidelines—The ATA 187 uses the Universal AC power supply 110/240V

### Power Outage

Your accessibility to emergency service through the phone is dependent on the phone being powered. If there is an interruption in the power supply, Service and Emergency Calling Service dialing will not function until power is restored. In the case of a power failure or disruption, you may need to reset or reconfigure equipment before using the Service or Emergency Calling Service dialing.

# Understanding Phone Configuration Files

Configuration files for a phone are stored on the TFTP server and define parameters for connecting to Cisco Unified Communications Manager. In general, any time you make a change in Cisco Unified Communications Manager that requires the phone to be reset, a change is automatically made to the phone's configuration file. If the system needs to reset or restart, both ports must reset or restart at the same time.

Configuration files also contain information about which image load the phone should be running. If this image load differs from the one that is currently loaded on a phone, the phone contacts the TFTP server to request the required load files. (These files are digitally signed to ensure the authenticity of the file source.)

In addition, if the device security mode in the configuration file is set to Authenticated and the CTL file on the phone has a valid certificate for Cisco Unified Communications Manager, the phone establishes a TLS connection to Cisco Unified Communications Manager. Otherwise, the phone establishes a TCP connection. For SIP phones, a TLS connection requires that the transport protocol in the phone configuration file be set to TLS, which corresponds to the transport type in the SIP Security Profile in Cisco Unified Communications Manager.

**Note**

If the device security mode in the configuration file is set to Authenticated or Encrypted, but the phone has not received a CTL file, the phone tries four times to obtain it so it can register securely.

**Note**

Cisco Extension Mobility Cross Cluster is an exception, in that the phone permits a TLS connection to Cisco Unified Communications Manager for secure signaling even without the CTL file.

If you configure security-related settings in Cisco Unified Communications Manager Administration, the phone configuration file will contain sensitive information. To ensure the privacy of a configuration file, you must configure it for encryption. For detailed information, see [Configuring Encrypted Phone Configuration Files](#) in *Cisco Unified Communications Manager Security Guide*.

A phone accesses a default configuration file named `XmlDefault.cnf.xml` only when the phone has not received a valid Trust List file containing a certificate assigned to the Cisco Unified Communications Manager and TFTP.

If auto registration is not enabled and you did not add the phone to the Cisco Unified Communications Manager database, the phone does not attempt to register with Cisco Unified Communications Manager. The phone continually displays the “Configuring IP” message until you either enable auto-registration or add the phone to the Cisco Unified Communications Manager database.

If the phone has registered before, the phone accesses the configuration file named `ATA<mac_address>.cnf.xml`, where `mac_address` is the MAC address of the phone.

For SIP phones, the TFTP server generates these SIP configuration files:

- SIP IP Phone:
  - For unsigned and unencrypted files—`ATA<mac>.cnf.xml`
  - For signed files—`ATA<mac>.cnf.xml.sgn`
  - For signed and encrypted files—`ATA<mac>.cnf.xml.enc.sgn`
- Dial Plan—`<dialplan>.xml`
  - No support “;” for second dial tone; “;” will be ignored

- No support > for configuring termination key
- No support + dial pattern which contains + will be ignored
- Maximum length of match string is **196**
- Maximum length of a dial pattern is **4095**
- Maximum rule set in one dial pattern is **100**

The filenames are derived from the MAC Address and Description fields in the Phone Configuration window of Cisco Unified Communications Manager Administration. The MAC address uniquely identifies the phone. For more information see the *Cisco Unified Communications Manager Administration Guide*.

For more information about how the phone interacts with the TFTP server, see the *Cisco Unified Communications Manager System Guide*, Cisco TFTP section.

## Understanding the ATA 187 Startup Process

When connecting to the VoIP network, the ATA 187 goes through a standard startup process, as described in [Table 2-1](#). Depending on your specific network configuration, not all of these process steps may occur on your ATA 187.

**Table 2-1**      **ATA 187 Startup Process**

| Task | Purpose   | Related Topics  |
|------|---|---|
| 1.   | Obtaining Power.<br>The ATA 187 uses external power.  | See <a href="#">Providing Power to the ATA 187, page 2-2</a> .  |
| 2.   | Loading the Stored Image.<br>The ATA 187 has non-volatile flash memory in which it stores firmware images and user-defined preferences. At startup, the phone runs a bootstrap loader that loads a phone image stored in flash memory. Using this image, the phone initializes its software and hardware. |   |
| 3.   | Obtaining an IP Address.<br>If the ATA 187 is using DHCP to obtain an IP address, the device queries the DHCP server to obtain one. If you are not using DHCP in your network, you must assign static IP addresses to each device locally.  |   |
| 4.   | Requesting the CTL file.<br>The TFTP server stores the CTL file. This file contains the certificates necessary for establishing a secure connection between the device and Cisco Unified Communications Manager.  | See the <i>Cisco Unified Communications Manager Security Guide</i> , <a href="#">Configuring the Cisco CTL Client</a> . |



**Table 2-1** ATA 187 Startup Process (continued)

| Task | Purpose   | Related Topics  |
|------|---|---|
| 5.   | Requesting the Configuration File.<br>The TFTP server has configuration files, which define parameters for connecting to Cisco Unified Communications Manager and other information for the ATA 187.  | See <a href="#">Understanding Phone Configuration Files</a> , page 2-3. |
| 6.   | Contacting Cisco Unified Communications Manager.<br>The configuration file defines how the ATA 187 communicates with Cisco Unified Communications Manager and provides a device with its load ID. After obtaining the file from the TFTP server, the device attempts to make a connection to the highest priority Cisco Unified Communications Manager on the list. If the security profile of the device is configured for secure signaling (encrypted or authenticated), and the Cisco Unified Communications Manager is set to secure mode, the device makes a TLS connection. Otherwise, it makes a nonsecure TCP connection. | See <a href="#">Understanding Phone Configuration Files</a> , page 2-3. |

## Adding the ATA 187 to the Cisco Unified Communications Manager Database

Before installing the ATA 187, you must choose a method for adding the devices to the Cisco Unified Communications Manager database. These sections describe the methods:

- [Adding the ATA 187 with Auto-Registration](#), page 2-6
- [Adding the ATA 187 with Cisco Unified Communications Manager Administration](#), page 2-6

Table 2-2 provides an overview of these methods for adding the ATA 187 to the Cisco Unified Communications Manager database.

**Table 2-2** Methods for Adding the ATA 187 to the Cisco Unified Communications Manager Database

| Method  | Requires MAC Address? | Notes  |
|---|-----------------------|--|
| Auto-registration   | No                    | <ul style="list-style-type: none"> <li>• Results in automatic assignment of directory numbers.</li> <li>• Not available when security or encryption is enabled.</li> </ul> |
| Using the Cisco Unified Communications Manager Administration | Yes                   | Requires phones to be added individually.  |

## Adding the ATA 187 with Auto-Registration

By enabling auto-registration before you begin installing the ATA 187, you can:

- Add devices without first gathering MAC addresses from the ATA 187.
- Automatically add a ATA 187 to the Cisco Unified Communications Manager database when you physically connect the phone to your IP telephony network. During auto-registration, Cisco Unified Communications Manager assigns the next available sequential directory number to the phone.
- Quickly enter devices into the Cisco Unified Communications Manager database and modify any settings, such as the directory numbers, from Cisco Unified Communications Manager.
- Move auto-registered devices to new locations and assign them to different device pools without affecting their directory numbers.



### Note

The ATA 187 will auto-register two devices in the Unified CM.

Auto-registration is disabled by default. In some cases, you may not want to use auto-registration; for example, if you want to assign a specific directory number to the phone or if you plan to use secure connection with Cisco Unified Communications Manager as described in *Cisco Unified Communications Manager Security Guide*. For information about enabling auto-registration, see the Enabling Auto-Registration in the *Cisco Unified Communications Manager Administration Guide*.



### Note

When you configure the cluster for mixed mode through the Cisco CTL client, auto-registration is automatically disabled. When you configure the cluster for nonsecure mode through the Cisco CTL client, auto-registration is not automatically enabled.

### Related Topics

[Adding the ATA 187 with Cisco Unified Communications Manager Administration, page 2-6](#)

## Adding the ATA 187 with Cisco Unified Communications Manager Administration

You can add the ATA 187 individually to the Cisco Unified Communications Manager database using Cisco Unified Communications Manager Administration. To do so, you first need to obtain the MAC address for each device.

For information about determining a MAC address, see [Determining the MAC Address of an ATA 187, page 2-7](#).

After you have collected MAC addresses, in Cisco Unified Communications Manager Administration, choose **Device > Phone** and click **Add New** to begin.



### Note

The first device used the MAC address and the second device uses the shifted MAC address (example, AABBCCDDEEFF to BBCCDDEEFF01). You can add two devices from the Unified CM administration page.

For complete instructions and conceptual information about Cisco Unified Communications Manager, see the *Cisco Unified Communications Manager Administration Guide* and the *Cisco Unified Communications Manager System Guide*.

**Related Topics**

[Adding the ATA 187 with Auto-Registration, page 2-6](#)

---

## Determining the MAC Address of an ATA 187

Several of the procedures that are described in this manual require you to determine the MAC address of an ATA 187. You can determine the MAC address for a device in any of these ways:

- Look at the MAC label on the back of the device.
- Display the web page for the device and click the **Device Information** hyperlink.





# CHAPTER 3

## Installing the ATA 187

This section describes how to connect the ATA 187 hardware and configure the ATA 187 by loading the QED and firmware files. You must install the QED file first and then install the firmware file.

After the equipment is in place, see [Figure 3-1](#) and follow the procedure to install the ATA 187.

**Figure 3-1** Cisco ATA Rear Panel Connections

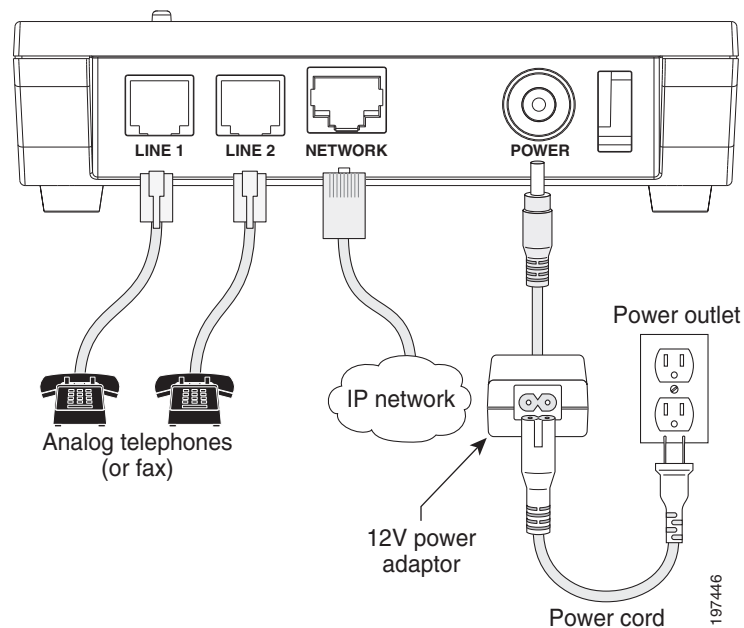

## Network Requirements

The ATA 187 acts as an endpoint on an IP telephony network. The following equipment is required:

- Call Control system
- Voice packet gateway—Required if you are connecting to the Public Switched Telephone Network (PSTN). A gateway is not required if an analog key system is in effect.
- Ethernet connection

## Safety Recommendations

To ensure general safety, follow these guidelines:

- Do not get this product wet or pour liquids into this device.
- Do not open or disassemble this product.
- Do not perform any action that creates a potential hazard to people or makes the equipment unsafe.
- Use only the power supply that comes with the ATA 187.



**Warning**

**Ultimate disposal of this product should be handled according to all national laws and regulations.**



**Warning**

**Read the installation instructions before you connect the system to its power source.**



**Warning**

**The plug-socket combination must be accessible at all times because it serves as the main disconnecting device.**



**Warning**

**Do not work on the system or connect or disconnect cables during periods of lightning activity.**



**Warning**

**To avoid electric shock, do not connect safety extra-low voltage (SELV) circuits to telephone-network voltage (TNV) circuits. LAN ports contain SELV circuits, and WAN ports contain TNV circuits. Some LAN and WAN ports both use RJ-45 connectors. Use caution when connecting cables.**

For translated warnings, see the *Regulatory Compliance and Safety Information for the Cisco ATA 187* manual.

## What the ATA 187 Package Includes

The ATA 187 package contains the following items:

- Cisco ATA 187 Analog Telephone Adaptor
- *Cisco ATA 187 Analog Telephone Adaptor at a Glance*
- *Cisco ATA 187 Analog Telephone Adaptor (SIP) Product Safety and User Manual*
- Regulatory Compliance and Safety Information for the ATA 187
- 12V power adaptor
- Power cord



**Note**

The ATA 187 is intended for use only with the 12V DC power adaptor that comes with the unit.

## Installing the ATA 187

To install an ATA 187, follow these steps:

### Procedure

- 
- Step 1** Connect the power supply to the Cisco DC Adapter port.
- Step 2** Connect a straight-through Ethernet cable from the network to the 10/100 SW port on the ATA 187. Each ATA 187 ships with one Ethernet cable in the box.
- 

**Note**

You can use either Category 3/5/5e/6 cabling for 10 Mbps connections, but you must use Category 5/5e/6 for 100 Mbps connections.

---

## Attaching a Phone to the ATA 187

You can attach one or two phones to an ATA 187 by connecting them to a line port of the ATA 187 with a RJ11 cable. The line LED will blink when there is activity on that line.

## Verifying the ATA 187 Startup Process

After the ATA 187 has power connected to it, the phone begins its startup process by cycling through these steps:

1. The LEDs are on.
  - a. Power
  - b. Line 1
  - c. Line 2
  - d. Set Up

The ATA 187 boots up in this step; it may take up to one minute.

2. The LEDs flash.

The ATA 187 is launching its application in this step.

3. Only the Power LED is on.

The ATA 187 is registering with Cisco Unified Communications Manager. You will hear a busy tone when you go offhook on the phone. It can take up to one minute for this to complete.

4. All of the LEDs flash again (Optional).

If the ATA 187 flash memory is erased or the load is corrupted, all the LEDs will flash again. The ATA 187 will download the image files and write to the flash. The ATA 187 will reboot and start from step 1.

When you go offhook on the phone, you will see the line LED on and you will hear dial tone. The ATA 187 has completed the startup process.

## Configuring Startup Network Settings

If you are not using DHCP in your network, you must configure these network settings on the ATA 187 after installing the device on the network:

- IP subnet information (subnet mask for IPv4)
- TFTP server IP address

You may also configure these optional settings as necessary:

Administration VLAN ID

Collect this information and see instructions in [Chapter 8, “Voice Menu Codes”](#).

## Configuring Security on the ATA 187

The security features protect against several threats, including threats to the identity of the phone and to data. These features establish and maintain authenticated communication streams between the phone and the Cisco Unified Communications Manager server, and digitally sign files before they are delivered.

For more information about the security features, see the *Cisco Unified Communications Manager Security Guide*.

You can initiate the installation of a Locally Significant Certificate (LSC) from the Security Configuration menu on the phone. This menu also lets you update or remove an LSC.

Before you begin, make sure that the appropriate Cisco Unified Communications Manager and the CAPF security configurations are complete:

- On Cisco Unified Communications Operating System Administration, verify that the CAPF certificate has been installed
- The CAPF is running and configured

See the *Cisco Unified Communications Manager Security Guide* for more information.

**Note**

---

If you want to update LSC, you need to use *reset to factory default* from [Chapter 8, “Voice Menu Codes”](#).

---





# CHAPTER 4

## Configuring the ATA 187

You must use Cisco Unified Communications Manager Administration to configure telephony features and assign users.

This chapter provides an overview of these configuration and setup procedures. Cisco Unified Communications Manager documentation provides detailed instructions for these procedures.

## Telephony Features Available for the ATA 187

Table 4-1 lists the supported telephony features, many of which you configure by using Cisco Unified Communications Manager Administration.

**Table 4-1**      *Telephony Features for the ATA 187*

| Feature                           | Description   | Configuration Reference   |
|-----------------------------------|---|---|
| Audible Message Waiting Indicator | <p>A stutter tone from the handset, headset, or speakerphone indicates that a user has one or more new voice messages on a line.</p> <p><b>Note</b>    The stutter tone is line-specific. You hear it only when using the line with the waiting messages.</p>             | <p>For more information, refer to:</p> <ul style="list-style-type: none"><li>• <i>Cisco Unified Communications Manager Administration Guide, Message Waiting Configuration.</i></li><li>• <i>Cisco Unified Communications Manager System Guide, Voice Mail Connectivity to Cisco Unified Communications Manager.</i></li></ul>  |
| cBarge                            | <p>Allows a user to join a non-private call on a shared phone line. cBarge adds a user to a call and converts it into a conference, allowing the user and other parties to access conference features.</p> <p>The phones support Barge on a shared conference bridge.</p> | <p>For more information, refer to:</p> <ul style="list-style-type: none"><li>• <i>Cisco Unified Communications Manager Administration Guide, Cisco Unified IP Phone Configuration.</i></li><li>• <i>Cisco Unified Communications Manager System Guide, Cisco Unified IP Phones.</i></li><li>• <i>Cisco Unified Communications Manager Features and Services Guide, Barge and Privacy.</i></li></ul> |

Table 4-1 Telephony Features for the ATA 187 (continued)

| Feature      | Description   | Configuration Reference  |
|--------------|---|--|
| Call forward | Allows users to redirect incoming calls to another number. Call forward options include Call Forward All, Call Forward Busy, Call Forward No Answer, and Call Forward No Coverage.  | For more information, refer to: <ul style="list-style-type: none"> <li>• <i>Cisco Unified Communications Manager Administration Guide, Directory Number Configuration.</i></li> <li>• <i>Cisco Unified Communications Manager System Guide, Cisco Unified IP Phones.</i></li> </ul>  |
| Call pickup  | Allows users to redirect a call that is ringing on another phone within their pickup group to their phone.<br>You can configure an audio and/or visual alert for the primary line on the phone. This alert notifies the users that a call is ringing in their pickup group.   | For more information, refer to the <i>Cisco Unified Communications Manager Features and Services Guide, Call Pickup.</i>   |
| Call waiting | Indicates (and allows users to answer) an incoming call that rings while on another call. Displays incoming call information on the phone screen.   | For more information, refer to the <i>Cisco Unified Communications System Guide, Understanding Directory Numbers.</i>  |
| Caller ID    | Displays caller identification such as a phone number, name, or other descriptive text on the phone screen.   | For more information, refer to: <ul style="list-style-type: none"> <li>• <i>Cisco Unified Communications Manager Administration Guide, Cisco Unified IP Phone Configurations.</i></li> <li>• <i>Cisco Unified Communications Manager System Guide, Understanding Route Plans.</i></li> <li>• <i>Cisco Unified Communications Manager Features and Services Guide, Call Display Restrictions.</i></li> <li>• <i>Cisco Unified Communications Manager Administration Guide, Directory Number Configuration.</i></li> </ul>   |
| Conference   | <ul style="list-style-type: none"> <li>• Allows a user to talk simultaneously with multiple parties by calling each participant individually. Conference features include Conference, Join, cBarge, and Meet-Me.</li> <li>• Allows a non-initiator in a standard (ad hoc) conference to add or remove participants; also allows any conference participant to join together two standard conferences on the same line.</li> </ul> | For more information, refer to: <ul style="list-style-type: none"> <li>• <i>Cisco Unified Communications Manager System Guide, Cisco Unified IP Phones.</i></li> <li>• The service parameter, Advance Adhoc Conference, (disabled by default in Cisco Unified Communications Manager Administration) allows you to enable these features.</li> </ul> <div style="border: 1px solid black; padding: 5px; margin-top: 10px;">  <p><b>Note</b> Be sure to inform your users whether these features are activated.</p> </div> |

Table 4-1 Telephony Features for the ATA 187 (continued)

| Feature                          | Description  | Configuration Reference  |
|----------------------------------|--|--|
| Direct transfer                  | Allows users to connect two calls to each other (without remaining on the line).   | For more information, refer to the <i>Cisco Unified Communications Manager System Guide</i> , <a href="#">Cisco Unified IP Phones</a> .  |
| Forced authorization codes (FAC) | Controls the types of calls that certain users can place.<br><b>Note</b> If you are using this feature, you must disable Enbloc dialing.   | For more information, refer to the <i>Cisco Unified Communications Manager Features and Services Guide</i> , <a href="#">Client Matter Codes and Forced Authorization Codes</a> .  |
| Group call pickup                | Allows a user to answer a call that is ringing on a directory number in another group.   | For more information, refer to the <i>Cisco Unified Communications Manager Features and Services Guide</i> , <a href="#">Call Pickup</a> .   |
| Hold/Resume                      | Allows the user to move a connected call between an active state and a held state.<br><b>Note</b> No support for resuming a call from a shared line party.   | For more information, refer to:<br>Requires no configuration, unless you want to use music on hold. See <a href="#">Music on hold</a> in this table for information.   |
| Meet-Me conference               | Allows a user to host a Meet-Me conference in which other participants call a predetermined number at a scheduled time.  | For more information refer to <i>Cisco Unified Communications Manager Administration Guide</i> , <a href="#">Meet-Me Number/Pattern Configuration</a> .  |
| Message Waiting                  | Defines directory numbers for message-waiting on and message-waiting off indicator. A directly connected voice-messaging system uses the specified directory number to set or to clear a message-waiting indication for a particular Cisco Unified IP Phone. | For more information refer to:<br><ul style="list-style-type: none"> <li>• <i>Cisco Unified Communications Manager Administration Guide</i>, <a href="#">Message Waiting Configuration</a>.</li> <li>• <i>Cisco Unified Communications Manager System Guide</i>, <a href="#">Voice Mail Connectivity to Cisco Unified Communications Manager</a>.</li> </ul> |
| Message waiting indicator        | A light on the handset that indicates that a user has one or more new voice messages.  | For more information refer to:<br><ul style="list-style-type: none"> <li>• <i>Cisco Unified Communications Manager Administration Guide</i>, <a href="#">Message Waiting Configuration</a>.</li> <li>• <i>Cisco Unified Communications Manager System Guide</i>, <a href="#">Voice Mail Connectivity to Cisco Unified Communications Manager</a>.</li> </ul> |
| Music on hold                    | Plays music while callers are on hold.   | For more information refer to <i>Cisco Unified Communications Manager Features and Services Guide</i> , <a href="#">Music On Hold</a> .  |

Table 4-1 Telephony Features for the ATA 187 (continued)

| Feature                | Description   | Configuration Reference  |
|------------------------|---|--|
| Privacy                | Prevents users who share a line from adding themselves to a call and from viewing information on their phone screens about the call of the other user.  | For more information refer to: <ul style="list-style-type: none"> <li>• <i>Cisco Unified Communications Manager Administration Guide, Cisco Unified IP Phone Configuration.</i></li> <li>• <i>Cisco Unified Communications Manager System Guide, Cisco Unified IP Phones.</i></li> <li>• <i>Cisco Unified Communications Manager Features and Services Guide Barge and Privacy.</i></li> </ul> |
| Redial                 | Allows users to call the most recently dialed phone number by pressing a softkey.   | Requires no configuration.   |
| Shared line            | Allows a user to have several phones that share the same phone number or allows a user to share a phone number with a coworker.   | For more information refer to the <i>Cisco Unified Communications Manager System Guide, Understanding Directory Numbers.</i>   |
| Speed dialing          | Allows users to speed dial a phone number by entering an assigned index code (1 to 9) on the phone keypad.<br><br><b>Note</b> You can use Speed Dialing while on-hook or off-hook.<br><br>Users assign index codes from the User Options web pages. | For more information, refer to: <ul style="list-style-type: none"> <li>• <i>Cisco Unified Communications Manager Administration Guide, Cisco Unified IP Phone Configuration.</i></li> <li>• <i>Cisco Unified Communications Manager System Guide, Cisco Unified IP Phones.</i></li> </ul>  |
| Time Zone Update       | Updates the IP phone with time zone changes.  | For more information, refer to the <i>Cisco Unified Communications Manager Administration Guide, Date/Time Group Configuration.</i>  |
| Voice-messaging system | Enables callers to leave messages if calls are unanswered.  | For more information refer to: <ul style="list-style-type: none"> <li>• <i>Cisco Unified Communications Manager Administration Guide, Cisco Voice-Mail Port Configuration.</i></li> <li>• <i>Cisco Unified Communications Manager System Guide, Voice Mail Connectivity to Cisco Unified Communications Manager.</i></li> </ul>  |

# Configuring Product Specific Configuration Parameters

Cisco Unified Communications Manager Administration allows you to set some product specific configuration parameters for the ATA 187. [Table 4-2](#) lists the configuration windows and their paths to configure the parameters.

**Table 4-2 Configuration Information**

| Configuration Window                  | Path   |
|---------------------------------------|--|
| Enterprise Phone Configuration window | System > Enterprise Phone Configuration                          |
| Common Phone Profile window           | Device > Device Settings > Common Phone Profile                  |
| Phone Configuration window            | Device > Phone; Product Specific Configuration portion of window |

[Table 4-3](#) lists the configuration parameters you can set using Cisco Unified Communications Manager Administration. You can set the configuration parameters using any of the three configuration windows listed in [Table 4-2](#).

When you set the parameters, select the Override Common Settings check box for each setting you wish to update. If you do not check this box, the corresponding parameter setting does not take effect.



**Note**

Some ATA 187 parameters are set from port 1 only. Setting the parameters from port 2 will have no effect. Set the following parameters from port 1 only—IVR Password, Phone Load Name, CDP, and Web Access.

**Table 4-3 Configuration Parameters for the ATA 187**

| Parameter                  | Description  |
|----------------------------|--|
| Auto Barge                 | Auto Barge adds a user to an active call. An offhook phone automatically adds the user (initiator) to the shared line call (target), and the users currently on the call receive a tone (if configured). Barge supports built-in conference and shared conference bridges.<br><br>The Auto Barge feature allows the user to go offhook and be added to the call. The Auto Barge feature supports built-in conferences and shared conference bridges. |
| Call Sequence              | <ul style="list-style-type: none"> <li>Bellcore FSK</li> <li>ETSI FSK</li> </ul>   |
| Callee Connect Polarity    | <ul style="list-style-type: none"> <li>User forward polarity while callee is connected</li> <li>User reverse polarity while callee is connected</li> </ul>   |
| Callee Disconnect Polarity | <ul style="list-style-type: none"> <li>User forward polarity while callee is disconnected</li> <li>User reverse polarity while callee is disconnected</li> </ul>   |
| Caller Connect Polarity    | <ul style="list-style-type: none"> <li>User forward polarity while caller is connected</li> <li>User reverse polarity while caller is connected</li> </ul>   |

**Table 4-3 Configuration Parameters for the ATA 187 (continued)**

| Parameter                                       | Description   |
|---|---|
| Caller Disconnect Polarity                      | <ul style="list-style-type: none"> <li>User forward polarity while caller is disconnected</li> <li>User reverse polarity while caller is disconnected</li> </ul>  |
| Caller ID                                       | <ul style="list-style-type: none"> <li>BT FSK</li> <li>Bellcore FSK</li> <li>ETSI FSK</li> </ul>  |
| Cisco Discovery Protocol (CDP)                  | Enable or disable the CDP function of the ATA 187   |
| Fax Error Correction Mode Override              | <p>You can set the fax error correction mode override values to one of the following settings:</p> <ul style="list-style-type: none"> <li>Default</li> <li>On</li> <li>Off</li> </ul>   |
| Fax Mode  | <p>The Cisco ATA supports two fax modes:</p> <ul style="list-style-type: none"> <li>Fax Pass-Through—Allows fax and modem traffic to pass through a voice port</li> <li>T.38 Fax Relay—Allows for a more robust protocol for fax transmission over packet networks</li> </ul> |
| Hookflash Timer<br>(100 ms to 1500 ms)          | <p>Hookflash Timer</p> <p>The time to validate hookflash event</p>  |
| Impedance                                       | The ATA 187 provides multiple impedance values, such as 600 ohm for use in the United States  |
| Input Audio Level                               | Gain value of Network-to-Phone  |
| IVR Password                                    | ATA187 IVR password   |
| Maximum Fax Rate                                | Indicates the maximum fax rate—2400 b/s to 14400 b/s  |
| Offhook Validation Timer<br>(100 ms to 1000 ms) | <p>Offhook Validation Timer</p> <p>Indicates the time to validate an offhook event</p>  |
| Onhook Delay Timer<br>(0 ms to 155 ms)          | <p>On-hook Delay Timer</p> <p>Indicates the time to delay an onhook event</p>   |
| Onhook Validation Timer                         | <p>Onhook Validation Timer</p> <p>Indicates time to validate an onhook event</p>  |
| Output Audio Level                              | Gain value of Phone-to-Network  |
| Web Access                                      | Enable or disable web access on the ATA 187   |

## Adding Users to Cisco Unified Communications Manager

Adding users to Cisco Unified Communications Manager allows you to display and maintain information about users and allows each user to perform these tasks:

- Access the corporate directory and other customized directories from an ATA 187.

- Create a personal directory.
- Set up speed dial and call forwarding numbers.
- Subscribe to services that are accessible from an ATA 187.

You can add users to Cisco Unified Communications Manager using either of these methods:

- To add users individually, choose **User Management > End User** from Cisco Unified Communications Manager Administration.

Refer to *Cisco Unified Communications Manager Administration Guide* for more information about adding users. Refer to *Cisco Unified Communications Manager System Guide* for details about user information.







## CHAPTER 5

# Configuring Fax Services

---

The ATA 187 provides two modes of fax services that are capable of internetworking with Cisco IOS gateways over IP networks. These modes are called *fax pass-through mode* and *T.38 fax relay mode*.

With *fax pass-through mode*, the ATA 187 encodes fax traffic within the G.711 voice codec and passes it through the Voice Over IP (VoIP) network as though the fax were a voice call.

With *T.38 fax relay mode*, the ATA 187 supports the transmission of faxes, in real time, between two standard fax terminals communicating over SIP networks. T.38 fax relay mode provides a more reliable and error-free method of sending faxes over an IP network

## Using Fax Mode

You can choose the preferred fax mode on the phone configuration page of the Unified CM administration page. From the fax mode pull-down window, choose one of the following modes:

- Fax pass-through
- T.38 fax relay

You can set the Fax Error correction mode override values. From the fax mode pull-down window, choose one of the following modes:

- On
- Off
- Default

You can also set the maximum fax rate values from the phone configuration menu by choosing one of the values on the pull-down window.



**Note**

---

When the fax mode is T.38 fax relay, Message Transfer Part (MTP) cannot be enabled.

---

## Fax Modem Standards



**Note**

---

V.34 is supported for modem only, not for fax.

---

The ATA 187 supports the following fax modem standards:

- ITU-T V.34
- ITU-T V.34 Annex 12
- K56flex
- V.21
- V.22
- V.23
- V.32
- V.32bis
- V.44
- V.90
- V.92

## Fax Modem Speeds

The ATA 187 supports the following fax modem speeds:

- 14.4 kb/s
- 12 kb/s
- 9.6 kb/s
- 7.2 kb/s
- 4.8 kb/s
- 2.4 kb/s



## CHAPTER 6

# Troubleshooting and Maintenance

---

This chapter provides information that can assist you in troubleshooting problems with your ATA 187 or with your IP telephony network. It also explains how to clean and maintain your phone.

This chapter includes these topics:

- [Resolving Startup Problems, page 6-1](#)
- [ATA 187 Resets Unexpectedly, page 6-5](#)
- [Troubleshooting ATA 187 Security, page 6-7](#)
- [General Troubleshooting Tips, page 6-7](#)
- [Where to Go for More Troubleshooting Information, page 6-9](#)
- [Cleaning the ATA 187, page 6-10](#)

## Resolving Startup Problems

After installing an ATA 187 into your network and adding it to Cisco Unified Communications Manager, the phone should start up as described in the [Installing the ATA 187, page 3-3](#). If the phone does not start up properly, see the following sections for troubleshooting information:

- [Symptom: The ATA 187 Does Not Go Through its Normal Startup Process, page 6-1](#)
- [Symptom: The ATA 187 Does Not Register with Cisco Unified Communications Manager, page 6-2](#)
- [Symptom: ATA 187 Unable to Obtain IP Address, page 6-4](#)

### Symptom: The ATA 187 Does Not Go Through its Normal Startup Process

When you connect a phone in the network port, the phone should go through its normal startup process as described in the [Verifying the ATA 187 Startup Process, page 3-3](#). If the phone does not go through the startup process, the cause may be faulty cables, bad connections, network outages, lack of power, and so on. Or, the phone may not be functional.

To determine whether the phone is functional, follow these suggestions to systematically eliminate these other potential problems:

1. Verify that the network port is functional:
  - Exchange the Ethernet cables with cables that you know are functional.

- Disconnect a functioning phone from another port and connect it to this network port to verify the port is active.
  - Connect the phone that will not start up to a different network port that is known to be good.
  - Connect the phone that will not start up directly to the port on the switch, eliminating the patch panel connection in the office.
2. Verify that the phone is receiving power:
    - If you are using external power, verify that the electrical outlet is functional.
    - If you are using the external power supply, switch with a unit that you know to be functional.
  3. If the phone still does not start up properly, perform a factory reset of the phone.

## Symptom: The ATA 187 Does Not Register with Cisco Unified Communications Manager

If the phone proceeds past the first stage of the startup process (LED buttons flashing on and off) but continues to cycle through the messages, the phone is not starting up properly. The phone cannot successfully start up unless it is connected to the Ethernet network and it has registered with a Cisco Unified Communications Manager server.

These sections can assist you in determining the reason the phone is unable to start up properly:

- [Registering the Phone with Cisco Unified Communications Manager, page 6-4](#)
- [Checking Network Connectivity, page 6-2](#)
- [Verifying TFTP Server Settings, page 6-2](#)
- [Verifying DNS Settings, page 6-3](#)
- [Verifying Cisco Unified Communications Manager Settings, page 6-3](#)
- [Cisco Unified Communications Manager and TFTP Services Are Not Running, page 6-3](#)
- [Creating a New Configuration File, page 6-3](#)
- [Registering the Phone with Cisco Unified Communications Manager, page 6-4](#)

### Checking Network Connectivity

If the network is down between the phone and the TFTP server or Cisco Unified Communications Manager, the phone cannot start up properly. Ensure that the network is currently running.

### Verifying TFTP Server Settings

You can determine the IP address of the TFTP server used by the ATA 187 by entering **http://x.x.x.x** where x.x.x.x is the IP address of the ATA 187.

If you have assigned a static IP address to the phone, you must manually enter a setting for the TFTP Server 1 option. See [“Accessing the IVR and Configuring Your Phone Setting”](#) section on page 8-1.

If you are using DHCP, the phone obtains the address for the TFTP server from the DHCP server. Check the IP address configured in Option 150.

You can also enable the phone to use an alternate TFTP server. Such a setting is particularly useful if the phone was recently moved from one location to another. See [“Accessing the IVR and Configuring Your Phone Setting”](#) section on page 8-1 for instructions.

## Verifying DNS Settings

If you are using DNS to refer to the TFTP server or to Cisco Unified Communications Manager, you must ensure that you have specified a DNS server. Verify this setting by entering `http://x.x.x.x` where `x.x.x.x` is the IP address of the ATA 187. You should also verify that there is a CNAME entry in the DNS server for the TFTP server and for the Cisco Unified Communications Manager system.

You must also ensure that DNS is configured to do reverse look-ups.

## Verifying Cisco Unified Communications Manager Settings

Enter `http://x.x.x.x` where `x.x.x.x` is the IP address of the ATA 187 to find the active and standby Cisco Unified Communications Manager settings.

## Cisco Unified Communications Manager and TFTP Services Are Not Running

If the Cisco Unified Communications Manager or TFTP services are not running, phones may not be able to start up properly. However, in such a situation, it is likely that you are experiencing a system-wide failure, and that other phones and devices are unable to start up properly.

If the Cisco Unified Communications Manager service is not running, all devices on the network that rely on it to make phone calls will be affected. If the TFTP service is not running, many devices will not be able to start up successfully.

To start a service, follow these steps:

### Procedure

- 
- Step 1** From Cisco Unified Communications Manager Administration, choose **Cisco Unified Serviceability** from the Navigation drop-down list.
  - Step 2** Choose **Tools > Control Center - Network Services**.
  - Step 3** Choose the primary Cisco Unified Communications Manager server from the Server drop-down list. The window displays the service names for the server that you chose, the status of the services, and a service control panel to stop or start a service.
  - Step 4** If a service has stopped, click its radio button and then click the **Start** button. The Service Status symbol changes from a square to an arrow.
- 



### Note

A service must be activated before it can be started or stopped. To activate a service, choose **Tools > Service Activation**.

---

## Creating a New Configuration File

If you continue to have problems with a particular phone that other suggestions in this chapter do not resolve, the configuration file may be corrupted.

To create a new configuration file, follow these steps:

#### Procedure

- 
- Step 1** From Cisco Unified Communications Manager, choose **Device > Phone > Find** to locate the phone experiencing problems.
  - Step 2** Choose **Delete** to remove the phone from the Cisco Unified Communications Manager database.
  - Step 3** Add the phone back to the Cisco Unified Communications Manager database. See [Attaching a Phone to the ATA 187, page 3-3](#) for details.
  - Step 4** Power cycle the phone.



#### Note

When you remove a phone from the Cisco Unified Communications Manager database, its configuration file is deleted from the Cisco Unified Communications Manager TFTP server. The phone's directory number or numbers remain in the Cisco Unified Communications Manager database. They are called "unassigned DNs" and can be used for other devices. If unassigned DNs are not used by other devices, delete them from the Cisco Unified Communications Manager database. You can use the Route Plan Report to view and delete unassigned reference numbers. See the Cisco Unified Communications Manager Administration Guide for more information.



#### Note

Changing the buttons on a phone button template, or assigning a different phone button template to a phone, may result in directory numbers that are no longer accessible from the phone. The directory numbers are still assigned to the phone in the Cisco Unified Communications Manager database, but there is no button on the phone with which calls can be answered. These directory numbers should be removed from the phone and deleted if necessary.

## Registering the Phone with Cisco Unified Communications Manager

A phone can register with a Cisco Unified Communications Manager server only if the phone has been added to the server or if auto-registration is enabled. Review the information and procedures in the [Attaching a Phone to the ATA 187, page 3-3](#) to ensure that the phone has been added to the Cisco Unified Communications Manager database.

To verify that the phone is in the Cisco Unified Communications Manager database, choose **Device > Phone > Find** from Cisco Unified Communications Manager Administration to search for the phone based on its MAC Address. For information about determining a MAC address, see [Determining the MAC Address of an ATA 187, page 2-7](#).

If the phone is already in the Cisco Unified Communications Manager database, its configuration file may be damaged. See [Adding Users to Cisco Unified Communications Manager, page 4-6](#) for assistance.

## Symptom: ATA 187 Unable to Obtain IP Address

If a phone is unable to obtain an IP address when it starts up, the phone may be not be on the same network or VLAN as the DHCP server, or the switch port to which the phone is connected may be disabled.

Make sure that the network or VLAN to which the phone is connected has access to the DHCP server, and make sure that the switch port is enabled.

# ATA 187 Resets Unexpectedly

If users report that their phones are resetting during calls or while idle on their desk, you should investigate the cause. If the network connection and Cisco Unified Communications Manager connection are stable, a Cisco Unified IP Phone should not reset on its own.

Typically, a phone resets if it has problems connecting to the Ethernet network or to Cisco Unified Communications Manager. These sections can help you identify the cause of a phone resetting in your network:

- [Verifying Physical Connection, page 6-5](#)
- [Identifying Intermittent Network Outages, page 6-5](#)
- [Verifying DHCP Settings, page 6-5](#)
- [Checking Static IP Address Settings, page 6-6](#)
- [Verifying Voice VLAN Configuration, page 6-6](#)
- [Eliminating DNS or Other Connectivity Errors, page 6-6](#)
- [Checking Power Connection, page 6-7](#)

## Verifying Physical Connection

Verify that the Ethernet connection to which the ATA 187 is connected is up. For example, check whether the particular port or switch to which the phone is connected is down and that the switch is not rebooting. Also make sure that there are no cable breaks.

## Identifying Intermittent Network Outages

Intermittent network outages affect data and voice traffic differently. Your network might have been experiencing intermittent outages without detection. If so, data traffic can resend lost packets and verify that packets are received and transmitted. However, voice traffic cannot recapture lost packets. Rather than retransmitting a lost network connection, the phone resets and attempts to reconnect its network connection.

If you are experiencing problems with the voice network, you should investigate whether an existing problem is simply being exposed.

## Verifying DHCP Settings

Follow this process to help determine if the phone has been properly configured to use DHCP:

### Procedure

- 
- |               |  |
|---------------|--|
| <b>Step 1</b> | Verify that you have properly configured the phone to use DHCP. See <a href="#">Configuring Startup Network Settings, page 3-4</a> for more information. |
| <b>Step 2</b> | Verify that the DHCP server has been set up properly.  |
| <b>Step 3</b> | Verify the DHCP lease duration. Cisco recommends that you set it to 8 days.  |
-

The ATA 187 sends messages with request type 151 to renew the DHCP address leases. If the DHCP server expects messages with request type 150, the lease will be denied, forcing the ATA 187 to restart and request a new IP address from the DHCP server.

## Checking Static IP Address Settings

If the phone has been assigned a static IP address, verify that you have entered the correct settings. See [Understanding Phone Configuration Files, page 2-3](#) for more information.

## Verifying Voice VLAN Configuration

If the ATA 187 appears to reset during heavy network usage (for example, following extensive web surfing on a computer connected to same switch as phone), it is likely that you do not have a voice VLAN configured.

Isolating the phones on a separate auxiliary VLAN increases the quality of the voice traffic.

## Eliminating DNS or Other Connectivity Errors

If the phone continues to reset, follow these steps to eliminate DNS or other connectivity errors:

### Procedure

- 
- Step 1** Use the IVR to reset phone settings to their default values. See [Accessing the IVR and Configuring Your Phone Setting, page 8-1](#) for details.
  - Step 2** Modify DHCP and IP settings:
    - a. Disable DHCP.
    - b. Assign static IP values to the phone. See [Understanding Phone Configuration Files, page 2-3](#) for instructions. Use the same default router setting used for other functioning ATA 187.
    - c. Assign TFTP server. Use the same TFTP server used for other functioning ATA 187.
  - Step 3** On the Cisco Unified Communications Manager server, verify that the local host files have the correct Cisco Unified Communications Manager server name mapped to the correct IP address.
  - Step 4** From Cisco Unified Communications Manager, choose **System > Server** and verify that the server is referred to by its IP address and not by its DNS name.
  - Step 5** From Cisco Unified Communications Manager, choose **Device > Phone** and verify that you have assigned the correct MAC address to this Cisco Unified IP Phone. For information about determining a MAC address, see [Determining the MAC Address of an ATA 187, page 2-7](#).
  - Step 6** Power cycle the phone.
-



## Checking Power Connection

In most cases, a phone will restart if it powers up by using external power but loses that connection and switches to PoE. Similarly, a phone may restart if it powers up by using PoE and then gets connected to an external power supply.

## Troubleshooting ATA 187 Security

Table 6-1 provides troubleshooting information for the security features on the ATA 187. For information relating to the solutions for any of these issues, and for additional troubleshooting information about security, see the *Cisco Unified Communications Manager Security Guide*.

**Table 6-1 ATA 187 Security Troubleshooting**

| Problem   | Possible Cause   |
|---|--|
| <b>CTL File Problems</b>  |  |
| Device authentication error.  | CTL file does not have a Cisco Unified Communications Manager certificate or has an incorrect certificate. |
| Phone cannot authenticate CTL file.   | The security token that signed the updated CTL file does not exist in the CTL file on the phone.           |
| Phone cannot authenticate any of the configuration files other than ITL file. | The configuration file may not be signed by the corresponding certificate in the phone's Trust List.       |
| Phone does not register with Cisco Unified Communications Manager.            | The CTL file does not contain the correct information for the Cisco Unified Communications Manager server. |
| Phone does not request signed configuration files.                            | The CTL file does not contain any TFTP entries with certificates.  |

## General Troubleshooting Tips

Table 6-2 provides general troubleshooting information for the ATA 187.

**Table 6-2 ATA 187 Troubleshooting**

| Summary  | Explanation   |
|--|---|
| Daisy-chaining phones  | Cisco does not support connecting a phone to another phone through the PC port. Each phone should directly connect to a switch port. If phones are connected together in a line (by using the PC port), the phones will not work.                           |
| Poor quality when calling mobile phones using the G.729 protocol | In Cisco Unified Communications Manager, you can configure the network to use the G.729 protocol (the default is G.711). When using G.729, calls between a phone and a mobile phone will have poor voice quality. Use G.729 only when absolutely necessary. |

Table 6-2 ATA 187 Troubleshooting (continued)

| Summary   | Explanation   |
|---|---|
| Prolonged broadcast storms cause phones to reset, or be unable to make or answer a call | A prolonged Layer 2 broadcast storm (lasting several minutes) on the voice VLAN may cause phones to reset, lose an active call, or be unable to initiate or answer a call. Phones may not come up until a broadcast storm ends.   |
| Moving a network connection from the phone to a workstation                             | <p>If you are powering your phone through the network connection, you must be careful if you decide to unplug the phone's network connection and plug the cable into a desktop computer.</p> <p><br/><b>Caution</b> The computer's network card cannot receive power through the network connection; if power comes through the connection, the network card can be destroyed. To protect a network card, wait 10 seconds or longer after unplugging the cable from the phone before plugging it into a computer. This delay gives the switch enough time to recognize that there is no longer a phone on the line and to stop providing power to the cable.</p> |
| Changing the phone configuration  | By default, the network configuration options are locked to prevent users from making changes that could impact their network connectivity. You must unlock the network configuration options before you can configure them.  |
| Dual-Tone Multi-Frequency (DTMF) delay  | When you are on a call that requires keypad input, if you press the keys too quickly, some of them might not be recognized.   |
| Codec mismatch between the phone and another device                                     | The RxType and the TxType statistics show the codec that is being used for a conversation between this ATA 187 and the other device. The values of these statistics should match. If they do not, verify that the other device can handle the codec conversation or that a transcoder is in place to handle the service.  |
| Sound sample mismatch between the phone and another device                              | The RxSize and the TxSize statistics show the size of the voice packets that are being used in a conversation between this ATA 187 and the other device. The values of these statistics should match.   |
| Gaps in voice calls   | Check the AvgJtr and the MaxJtr statistics. A large variance between these statistics might indicate a problem with jitter on the network or periodic high rates of network activity.   |

Table 6-2 ATA 187 Troubleshooting (continued)

| Summary                                | Explanation  |
|--|--|
| Loopback condition                     | <p>A loopback condition can occur when the following conditions are met:</p> <ul style="list-style-type: none"> <li>• The SW Port Configuration option in the Network Configuration menu on the phone is set to <b>10 Half</b> (10-BaseT/half duplex)</li> <li>• The phone receives power from an external power supply</li> <li>• The phone is powered down (the power supply is disconnected)</li> </ul> <p>In this case, the switch port on the phone can become disabled and the following message will appear in the switch console log:</p> <pre>HALF_DUX_COLLISION_EXCEED_THRESHOLD</pre> <p>To resolve this problem, re-enable the port from the switch.</p> |
| One-way audio                          | <p>When at least one person in a call does not receive audio, IP connectivity between phones is not established. Check the configurations in routers and switches to ensure that IP connectivity is properly configured.</p>   |
| Peer to peer image distribution fails. | <p>If the peer to peer image distribution fails, the phone will default to using the TFTP server to download firmware. Access the log messages stored on the remote logging machine to help debug the peer to peer image distribution feature.</p> <p><b>Note</b> These log messages are different than the log messages sent to the phone log.</p>  |
| Phone call cannot be established       | <p>The phone does not have a DHCP IP address, is unable to register to Cisco Unified Communications Manager, and shows a Configuring IP or Registering message.</p> <p>Verify the following:</p> <ol style="list-style-type: none"> <li>1. The Ethernet cable is attached.</li> <li>2. The Cisco CallManager service is running on the Cisco Unified Communications Manager server.</li> <li>3. Both phones are registered to the same Cisco Unified Communications Manager.</li> <li>4. Audio server debug and capture logs are enabled for both phones. If needed, enable Java debug.</li> </ol>   |

## Where to Go for More Troubleshooting Information

If you have additional questions about troubleshooting the ATA 187, several Cisco.com web sites can provide you with more tips. Choose from the sites available for your access level.

- ATA 187 Troubleshooting Resources:

[http://www.cisco.com/en/US/products/hw/gatecont/ps514/tsd\\_products\\_support\\_series\\_home.html](http://www.cisco.com/en/US/products/hw/gatecont/ps514/tsd_products_support_series_home.html)

- Cisco Products and Services (Technical Support and Documentation):  
<http://www.cisco.com/cisco/web/support/index.html>

## Cleaning the ATA 187

To clean your ATA 187, use a soft, dry cloth to wipe the surface. Do not apply liquids or powders directly on the device. As with all non-weather-proof electronics, liquids and powders can damage the components and cause failures.



## CHAPTER 7

# Using SIP Supplementary Services

---

SIP supplementary services are services that you can use to enhance your telephone service. These services include call forward, call return, call forwarding and conference calling.

## Common Supplementary Services

The supplementary services described in this section, and their configuration and implementation, depend on the system of the country in which the service is activated. For information about your country's implementation of services, contact your local Cisco equipment provider.

This section contains the following topics:

- [Attended Transfer, page 7-2](#)
- [Call Pickup, page 7-2](#)
- [Caller ID, page 7-2](#)
- [Call-Waiting Caller ID, page 7-2](#)
- [Call Hold, page 7-2](#)
- [Group Call Pickup, page 7-3](#)
- [Meet–Me Conference, page 7-3](#)
- [Privacy, page 7-3](#)
- [Shared Line, page 7-3](#)
- [Speed Dial, page 7-4](#)
- [Redial, page 7-4](#)
- [Unattended Transfer, page 7-4](#)
- [Voice Mail Indication, page 7-5](#)
- [Voice-Messaging System, page 7-5](#)
- [Making a Conference Call in the United States, page 7-5](#)
- [Making a Conference Call in Sweden, page 7-6](#)
- [Call Waiting in the United States, page 7-6](#)
- [Call Waiting in Sweden, page 7-6](#)
- [About Call Forwarding, page 7-6](#)
- [Call Forwarding in the United States, page 7-7](#)

- [Call Forwarding in Sweden, page 7-7](#)

## Attended Transfer

This feature allows a user to transfer an existing call to another phone number after first consulting with the dialed party before the user hangs up. Perform the following steps to complete an attended transfer:

### Procedure

---

- Step 1** Press the flash button on the phone handset to put the existing party on hold and get a dial tone.
  - Step 2** Dial the phone number to which the existing party is being transferred.
  - Step 3** When the callee answers the phone, you may consult with the callee and then transfer the existing party by hanging up your phone handset.
- 

## Call Pickup

Allows you to answer a call that is ringing on another phone within your call pickup group. Perform the following steps to use the call pickup feature:

### Procedure

---

- Step 1** Pick up the phone handset.
  - Step 2** Press **\*\*3**.
- 

## Caller ID

When the phone rings, the ATA 187 sends a Caller ID signal to the phone between the first and second ring (with name, phone number, time, and date information, if these are available).

## Call-Waiting Caller ID

The ATA 187 plays a call waiting tone, then sends an off-hook Caller ID signal to the phone immediately after the first tone burst.

The ATA 187 sends the name, phone number, time, and date information, if these are available.

## Call Hold

This feature allows the user to place an active state in a held state.

## Group Call Pickup

Allows you to answer a call on a phone that is outside your call pickup group by:

- Using a group pickup number
- Dialing the ringing phone's number

Perform the following steps to use the group call pickup feature:

### Procedure

---

**Step 1** Pick up the phone handset.

**Step 2** Press **\*\*4** > *group ID* > #.

---

## Meet–Me Conference

This feature allows a user to host a Meet–Me conference in which other participants call a predetermined number at a scheduled time. Perform the following steps to complete a meet–me conference:

### Procedure

---

**Step 1** Pick up the phone handset.

**Step 2** Press **\*\*5** > *room ID* > #.

---

## Privacy

This feature prevents users who share a line from adding themselves to a call and from viewing information on their phone screens about the call of the other user. Perform the following steps to enable or disable the privacy feature:

### Procedure

---

**Step 1** Pick up the phone handset.

**Step 2** During an active call, press **\*\*8** to enable the privacy feature.

**Step 3** During an active call, press **\*\*9** to disable the privacy feature.

---

## Shared Line

This feature allows a user to have multiple phones that share the same phone number or allows a user to share a phone number with a coworker.

Perform the following steps to enable or disable a shared line:

**Procedure**

- 
- Step 1** Pick up the phone handset.
- Step 2** Press **\*\*6** to enable the shared line feature.
- Step 3** Press **\*\*7** to disable the shared line feature.
- 

## Speed Dial

This feature allows users to speed dial a phone number by entering an assigned index code (\*1 to \*9) on the phone keypad.

## Redial

Allows users to call the most recently dialed phone number by pressing the **\*#** buttons.

## Unattended Transfer

This feature allows a user to transfer an existing call to another phone number without waiting for the dialed party to answer before the user hangs up. Two methods exist for performing an unattended transfer:

- [Semi-unattended Transfer, page 7-4](#)
- [Fully Unattended Transfer, page 7-5](#)

## Semi-unattended Transfer

Perform the following steps to complete a semi-unattended transfer:

**Procedure**

- 
- Step 1** Press the flash button on the phone handset to put the other party on hold and get a dial tone.
- Step 2** Dial the phone number to which you would like to transfer the other party.
- Step 3** Wait for at least one ring and then hang up your phone to transfer the other party.
-



## Fully Unattended Transfer

Perform the following steps to complete a fully unattended transfer:

### Procedure

---

- Step 1** Press the flash button on the phone handset to put the other party on hold and get a dial tone.
  - Step 2** Press **#90** (the transfer service activation code) on your phone keypad, then enter the phone number to which you want to transfer the other party, then press **#**.
  - Step 3** Hang up your phone.
- 

## Voice Mail Indication

This feature allows the ATA 187 to play an intermittent dial tone if there is a message in the user's voice mail box.

## Voice-Messaging System

This feature enables callers to leave messages if calls are unanswered or access voice messages. Perform the following steps to access the voice-messaging system:

### Procedure

---

- Step 1** Pick up the phone handset.
  - Step 2** Press **\*0**.
- 

## Making a Conference Call in the United States

### Procedure

---

- Step 1** Dial the first number.
  - Step 2** When the person you called answers, press the flash or receiver button on the phone handset. This will put the first person you called on hold and you will receive a dial tone.
  - Step 3** Dial the second person and speak normally when that person answers.
  - Step 4** To conference with both callers at the same time, perform a hook flash.
  - Step 5** (Optional) To conference in additional callers, the last person called with an ATA 187 can call an additional person, that new person can then call someone else, and so on. This is known as *daisy-chaining*.
-

## Making a Conference Call in Sweden

### Procedure

---

- Step 1** Dial the first number.
  - Step 2** When the person you called answers, press the flash or receiver button on the phone handset. This will put the first person you called on hold and a dial tone will sound.
  - Step 3** Dial the second person and speak normally when that person answers.
  - Step 4** Perform a hook flash, then press **2** on your phone keypad to return to the first person. You can continue to switch back and forth between the two callers.
  - Step 5** To conference with both callers at the same time, perform a hook flash, then press **3** on the phone keypad. Once you conference all three callers, the only way to drop a caller is for that caller to hang up.
  - Step 6** (Optional) To conference in additional callers, the last person called with a ATA 187 can call an additional person, that new person can call someone else, and so on. This is known as “daisy-chaining.”
- 

## Call Waiting in the United States

If someone calls you while you are speaking on the phone, you can answer by performing a hook flash. You cannot conference in all three callers, but the first person you called could call someone else and daisy-chain them into the conference.

## Call Waiting in Sweden

If someone calls you while you are speaking on the phone, you can answer by performing a hook flash then pressing **2** on your phone keypad, or you can conference them with the person to whom you are already speaking by performing a hook flash then pressing **3**. You can also perform a hook flash then press **3** later during the call to create a conference call.

Performing a hook flash then pressing **1** hangs up the first caller and answers the second call. If there is no answer after one minute, the caller receives three beeps and a busy signal.

To enable call waiting for Sweden, go to the ATA 187 phone configuration page and select the value for Call Sequence as **Bellcore FSK**.



### Note

In ETSI mode, the user must pick up the call waiting rather than start the conference service. The user cannot trigger the call conference service directly, when there is a call waiting.

---

## About Call Forwarding

In SIP, the ATA 187 can control call forwarding and call return. The type of call forwarding that is supported for the ATA 187 is Forward Unconditional—Forwards every call that comes in.

## Call Forwarding in the United States

### Forward Unconditional

Press **#72** on your phone keypad; enter the number you want to forward call to; then press **#** again.

### Cancelling Call Forwarding

To cancel call forwarding, press **#73** on your phone keypad

## Call Forwarding in Sweden

### Forward Unconditional

Press **\*21\*** on your phone keypad; enter the number you want to forward calls to; then press **#**. To cancel, press **#21#**.





## CHAPTER 8

# Voice Menu Codes

---

This section contains information on accessing the Interactive Voice Response (IVR) and a quick-reference list of the voice configuration menu options for the ATA 187.

## Accessing the IVR and Configuring Your Phone Setting

To access the IVR and configure your phone settings, follow these steps:



**Note**

---

You can change the PIN on the Cisco Unified CM User Options web page.

---

### Procedure

---

**Step 1** To access the IVR, go off-hook on the phone connected to Line 1 and press the **Set Up** button on the front panel of the ATA 187.

The IVR prompts for a password.



**Note**

---

The ATA 187 allows you to enter only numerical values for password.

---

**Step 2** Enter the PIN by pressing the number keypad, followed by # button.

You are at the IVR main configuration menu.

**Step 3** Follow the voice prompts on the IVR. See [Table 8-1](#) for information on navigating the IVR.

**Step 4** To return to the main configuration menu, press #.

**Step 5** To exit the IVR, end the call.

---

Table 8-1 describes the various options in the IVR Configuration Menu

**Table 8-1 Navigating the IVR Configuration Menu**

| Action                         | IVR Code | Navigating Notes  |
|--------------------------------|----------|---|
| Review or Set Network Settings | 1        | <p>If DHCP is enabled, the IVR announces each network parameter.</p> <p>If DHCP is disabled, the IVR announces each network parameter, pausing in between to allow you to enter a new value.</p> <ol style="list-style-type: none"> <li>1. IVR announces the IP Address. To change the IP address for the phone, use the keypad to enter a new IP address, followed by the #. To retain the current IP address, press #.</li> <li>2. IVR announces the subnet mask. To change the subnet mask use the keypad to enter a new IP address, followed by the #. To retain the current subnet mask, press #.</li> </ol> <p> <b>Note</b> To enter the dot “.” that separates each octet in the IP address, press *.</p> <ol style="list-style-type: none"> <li>3. IVR announces the default gateway. To change the default gateway, use the keypad to enter a new IP address, followed by the #. To retain the current default gateway, press #.</li> </ol> |
| Review or Set TFTP Server      | 2        | <p>IVR announces the current TFTP setting.</p> <p>To change the TFTP server, use the keypad to enter a new IP address, followed by the #. To retain the current TFTP server, press #.</p> <p>To reset a TFTP server back to the TFTP server set by the DHCP server from a manually configured TFTP server, press *.</p> <p><b>Note</b> To enter the dot “.” that separates each octet in the IP address, press *.</p>   |
| Enable or Disable DHCP         | 3        | Press <b>3</b> to toggle DHCP to enable or disable.   |
| Review or Set the VLAN ID      | 4        | Press <b>4</b> to review and set the Administrator VLAN ID.   |
| Reset to factory settings      | 0        | <p>—</p> <p><b>Note</b> All configuration settings will reset to default factory settings, the and phone will reset. It will take some time for the phone to re-register. Select this option only when needed.</p>  |



# APPENDIX **A**

## ATA 187 Specifications

---

This section describes ATA187 specifications:

- [Physical Specifications, page A-1](#)
- [Electrical Specifications, page A-2](#)
- [Environmental Specifications, page A-2](#)
- [Physical Interfaces, page A-2](#)
- [Ringing Characteristics, page A-3](#)
- [Software Specifications, page A-3](#)
- [SIP Compliance Reference Information, page A-4](#)

## Physical Specifications

**Table A-1**      *Physical Specifications*

| <b>Description</b> | <b>Specification</b>                                   |
|--------------------|--|
| Dimensions         | 1.5 x 5.4 x 6.7 in. (3.8 x 13.7 x 17.0 cm) (H x W x D) |
| Weight             | 9.2 oz (260 g)   |

# Electrical Specifications

**Table A-2** *Electrical Specifications*

| Description      | Specification  |
|------------------|--|
| Power            | 0.25 to 12W (idle to peak)   |
| DC input voltage | +12.0 VDC at 1.0A maximum  |
| Power adaptor    | Universal AC/DC<br>~4.05 x 1.93 x 1.31 in. (~10.3 x 4.9 x 3.35 cm)<br>~4.23 oz (120 g) for the AC-input external power adaptor<br>~4.9 ft (1.5 m) DC cord<br>6 ft (1.8 m) cord<br>UL/cUL, CE approved<br>Class I adaptor |

# Environmental Specifications

**Table A-3** *Environmental Specifications*

| Description               | Specification              |
|---------------------------|----------------------------|
| Operating temperature     | 23 to 113°F (-5 to 45°C)   |
| Non-operating temperature | -13 to 158°F (-25 to 70°C) |
| Relative humidity         | 5 to 95% noncondensing     |

# Physical Interfaces

**Table A-4** *Physical Interfaces*

| Description  | Specification                                     |
|--------------|---|
| Ethernet     | One RJ-45 connector, IEEE 802.3 100BaseT standard |
| Analog phone | Two RJ-11 FXS voice ports                         |
| Power        | 12 VDC power connector                            |
| Power switch | Power switch to turn the ATA 187 on or off        |



# Ringing Characteristics

**Table A-5** Ringing Characteristics

| Description  | Specification   |
|--|---|
| Tip/ring interfaces for each RJ-11 FXS port (SLIC) |   |
| Ring voltage                                       | 40V <sub>RMS</sub> (typical, balanced ringing only)   |
| Ring frequency                                     | 20 Hz   |
| Ring waveform                                      | Trapezoidal with 1.2 to 1.6 crest factor  |
| Ring load  | 1400 ohm + 40μF   |
| Ringer equivalence number (REN)                    | Up to 5 REN per RJ-11 FXS port  |
| Loop impedance                                     | Up to 200 ohms (plus 430-ohm maximum phone DC resistance)   |
| On-hook/off-hook characteristics                   |   |
| On-hook voltage (tip/ring)                         | −48V  |
| Off-hook current                                   | 24 mA (nominal)   |
| RJ-11 FXS port terminating impedance option        | The ATA 187-II provides multiple impedance, such as 600 ohm for American SKU, 900 ohm for European SKU, 220 ohm (820 ohm    120nF) for Australian SKU, and so on. |

# Software Specifications

**Table A-6** Software Specifications (All Protocols)

| Description                     | Specification  |
|---------------------------------|--|
| Call progress tones             | Configurable for two sets of frequencies and single set of on/off cadence  |
| Dual-tone multifrequency (DTMF) | DTMF tone detection and generation   |
| Fax                             | Fax pass-through and T.38 fax relay mode.<br>Enhanced fax pass-through is supported on the Cisco ATA. Success of fax transmissions up to 14.4 kbps depends on network conditions, and fax modem/fax machine tolerance to those conditions. The network must have reasonably low network jitter, network delay, and packet-loss rate. |

Table A-6 Software Specifications (All Protocols) (continued)

| Description                    | Specification  |
|--------------------------------|--|
| Line-echo cancellation         | <ul style="list-style-type: none"> <li>Echo canceller for each port</li> <li>8 ms echo length</li> <li>Nonlinear echo suppression (ERL &gt; 28 dB for frequency = 300 to 2400 Hz)</li> <li>Convergence time = 250 ms</li> <li>ERLE = 10 to 20 dB</li> <li>Double-talk detection</li> </ul>                           |
| Out-of-band DTMF               | RFC 2833 AVT tones for SIP<br><b>Note</b> Cannot transmit RFC 2833 and in-band signalling, simultaneously.   |
| Configuration                  | <ul style="list-style-type: none"> <li>DHCP (RFC 2131)</li> <li>Web configuration via built-in Web server</li> <li>Touch-tone phone keypad configuration with voice prompt</li> <li>Basic boot configuration (RFC 1350 TFTP Profiling)</li> <li>Dial plan configuration</li> <li>Cisco Discovery Protocol</li> </ul> |
| Quality of Service             | <ul style="list-style-type: none"> <li>Class-of-service (CoS) bit-tagging (802.1P)</li> <li>Type-of-service (ToS) bit-tagging</li> </ul> <b>Note</b> Does not support CoS service.   |
| Security                       | RC4 encryption for TFTP configuration files  |
| Voice coder-decoders (codecs)  | <ul style="list-style-type: none"> <li>G.729, G.729A, G.729AB</li> <li>G.711A-law</li> <li>G.711<math>\mu</math>-law</li> </ul>  |
| Voice features                 | <ul style="list-style-type: none"> <li>Voice activity detection (VAD)</li> <li>Comfort noise generation (CNG)</li> <li>Dynamic jitter buffer (adaptive)</li> </ul>   |
| Voice-over-IP (VoIP) protocols | SIP (RFC 3261 bis)   |

## SIP Compliance Reference Information

Information on how the ATA 187 complies with the IETF definition of SIP as described in RFC 2543 is found at the following URL:

<http://www.ietf.org/rfc/rfc2543.txt>



# APPENDIX **B**

## Recommended ATA 187 Tone Parameter Values by Country

This section provides tables of recommended tone parameters for the followings countries, listed alphabetically:



**Note**

The extended tone format used by some countries is available with ATA 187 firmware version 9.0(3).

- [Australia](#)
- [Germany](#)
- [Italy](#)
- [New Zealand](#)
- [United States](#)

**Table B-1**      **Australia**

| Parameter    | Recommended Values                                 |
|--------------|--|
| DialTone     | 2,31163,30958,1477,1566,1,0,0,0                    |
| BusyTone     | 1,30958,0,2212,0,0,3000,3000,0                     |
| ReorderTone  | 1,31163,0,2086,0,0,3000,3000,0                     |
| RingbackTone | 102,31163,1477,30742,1654,2,3200,1600,3200,16000,0 |
| SITtone      | 1,30958,0,2212,0,0,20000,4000,0                    |

**Table B-2**      **Germany**

| Parameter    | Recommended Values              |
|--------------|---------------------------------|
| DialTone     | 1,30958,0,3125,0,1,0,0,0        |
| BusyTone     | 1,30958,0,1757,0,0,3840,3840,0  |
| ReorderTone  | 1,30958,0,1757,0,0,1920,1920,0  |
| RingbackTone | 1,30958,0,1971,0,0,8000,32000,0 |
| SITtone      | 1,30958,0,1757,0,0,1920,1920,0  |

**Table B-3 Italy**

| <b>Parameter</b> | <b>Recommended Values</b>                  |
|------------------|--|
| DialTone         | 101,30958,3125,0,0,2,1600,1600,4800,8000,0 |
| BusyTone         | 1,30958,0,1757,0,0,4000,4000,0             |
| ReorderTone      | 1,30958,0,1757,0,0,1600,1600,0             |
| RingbackTone     | 1,30958,0,1971,0,0,8000,32000,0            |
| SITtone          | 1,30958,0,1757,0,0,4000,4000,0             |

**Table B-4 New Zealand**

| <b>Parameter</b> | <b>Recommended Values</b>                             |
|------------------|---|
| DialTone         | 1,31163,0,3307,0,1,0,0,0                              |
| BusyTone         | 1,31163,0,1657,0,0,4000,4000,0                        |
| ReorderTone      | 1,24916,0,3483,0,0,4000,4000,0                        |
| RingbackTone     | 102,31163,1316,30742,1474,2,3200,1600,3200,16000,0    |
| SITtone          | 100,1,31163,1657,0,0,0,0,2,6000,800,6000,3200,0,0,2,0 |

**Table B-5 United States**

| <b>Parameter</b> | <b>Recommended Values</b>             |
|------------------|---------------------------------------|
| DialTone         | 2,31537,30830,1490,1859,1,0,0,0       |
| BusyTone         | 2,30466,28958,1246,1583,0,4000,4000,0 |
| ReorderTone      | 2,30466,28958,1246,1583,0,2000,2000,0 |
| RingbackTone     | 2,30830,30466,793,862,0,8000,24000,0  |
| SITtone          | 2,30466,28958,1246,1583,0,2000,2000,0 |



## GLOSSARY

---

### Numerics

**10BaseT** 10-Mbps baseband Ethernet specification using two pairs of twisted-pair cabling (Categories 3, 4, or 5): one pair for transmitting data and the other for receiving data. 10BASET, which is part of the IEEE 802.3 specification, has a distance limit of approximately 328 feet (100 meters) per segment.

---

### A

**A-law** ITU-T companding standard used in the conversion between analog and digital signals in PCM systems. A-law is used primarily in European phone networks and is similar to the North American  $\mu$ -law standard. See also companding and  $\mu$ -law.

**AVT tones** Out-of-bound signaling as defined in RFC 2833.

---

### C

**category-3 cable** One of five grades of UTP cabling described in the EIA/TIA-586 standard. Category 3 cabling is used in 10BaseT networks and can transmit data at speeds up to 10 Mbps.

**CED tone detection** Called station identification. A three-second, 2100 Hz tone generated by a fax machine answering a call, which is used in the hand-shaking used to set the call; the response from a called fax machine to a CNG tone.

**CELP** code excited linear prediction compression. Compression algorithm used in low bit-rate voice encoding. Used in ITU-T Recommendations G.728, G.729, G.723.1.

**CLIP** Calling Line Identification Presentation. Shows your identity to callers with Caller ID.

**CLIR** Calling Line Identification Restriction. Hides your identity from callers with Caller ID.

**CNG** Comfort Noise Generation

**codec** coder decoder. In Voice over IP, Voice over Frame Relay, and Voice over ATM, a DSP software algorithm used to compress/decompress speech or audio signals.

**companding** Contraction derived from the opposite processes of compression and expansion. Part of the PCM process whereby analog signal values are rounded logically to discrete scale-step values on a nonlinear scale. The decimal step number then is coded in its binary equivalent prior to transmission. The process is reversed at the receiving terminal using the same nonlinear scale. Compare with compression and expansion. See also a-law and  $\mu$ -law.

**compression** The running of a data set through an algorithm that reduces the space required to store or the bandwidth required to transmit the data set. Compare with companding and expansion.

**CoS** Class of service. An indication of how an upper-layer protocol requires a lower-layer protocol to treat its messages. In SNA subarea routing, CoS definitions are used by subarea nodes to determine the optimal route to establish a given session. A CoS definition comprises a virtual route number and a transmission priority field.

---

## D

**DHCP** Dynamic Host Configuration Protocol. Provides a mechanism for allocating IP addresses dynamically so that addresses can be reused when hosts no longer need them.

**dial peer** An addressable call endpoint. In Voice over IP (VoIP), there are two types of dial peers: POTS and VoIP.

**DNS** Domain Name System. System used on the Internet for translating names of network nodes into addresses.

**DSP** digital signal processor. A DSP segments the voice signal into frames and stores them in voice packets.

**DTMF** dual tone multifrequency. Tones generated when a button is pressed on a phone, primarily used in the U.S. and Canada.

---

## E

**E.164** The international public telecommunications numbering plan. A standard set by the ITU-T which addresses phone numbers.

**endpoint** A SIP terminal or gateway. An endpoint can call and be called. It generates and/or terminates the information stream.

**expansion** The process of running a compressed data set through an algorithm that restores the data set to its original size. Compare with companding and compression.

---

## F

**firewall** Router or access server, or several routers or access servers, designated as a buffer between any connected public networks and a private network. A firewall router uses access lists and other methods to ensure the security of the private network.

**FoIP** Fax over IP

**FQDN** Fully Qualified Domain (FQDN) format “mydomain.com” or “company.mydomain.com.”

**FSK** Frequency shift key

**FXO** Foreign Exchange Office. An FXO interface connects to the public switched phone network (PSTN) central office and is the interface offered on a standard phone. Cisco FXO interface is an RJ-11 connector that allows an analog connection at the PSTN central office or to a station interface on a PBX.

**FXS** Foreign Exchange Station. An FXS interface connects directly to a standard phone and supplies ring, voltage, and dial tone. Cisco's FXS interface is an RJ-11 connector that allows connections to basic phone service equipment, keysets, and PBXs.

---

## G

**G.711** Describes the 64-kbps PCM voice coding technique. In G.711, encoded voice is already in the correct format for digital voice delivery in the PSTN or through PBXs. Described in the ITU-T standard in its G-series recommendations.

**G.723.1** Describes a compression technique that can be used for compressing speech or audio signal components at a very low bit rate as part of the H.324 family of standards. This Codec has two bit rates associated with it: 5.3 and 6.3 kbps. The higher bit rate is based on ML-MLQ technology and provides a somewhat higher quality of sound. The lower bit rate is based on CELP and provides system designers with additional flexibility. Described in the ITU-T standard in its G-series recommendations.

**G.729A** Describes CELP compression where voice is coded into 8-kbps streams. There are two variations of this standard (G.729 and G.729 Annex A) that differ mainly in computational complexity; both provide speech quality similar to 32-kbps ADPCM. Described in the ITU-T standard in its G-series recommendations.

**gateway** A gateway allows SIP or H.323 terminals to communicate with terminals configured to other protocols by converting protocols. A gateway is the point where a circuit-switched call is encoded and repackaged into IP packets.

---

## H

**H.323** H.323 allows dissimilar communication devices to communicate with each other by using a standard communication protocol. H.323 defines a common set of CODECs, call setup and negotiating procedures, and basic data transport methods.

---

## I

**ICMP** Internet Control Message Protocol

**IP** Internet Protocol. Network layer protocol in the TCP/IP stack offering a connectionless internet network service. IP provides features for addressing, type-of-service specification, fragmentation and reassembly, and security. Defined in RFC 791.

**IVR** Interactive voice response. Term used to describe systems that provide information in the form of recorded messages over phone lines in response to user input in the form of spoken words or, more commonly, DTMF signaling.

---

## L

**LDAP** Lightweight Directory Access Protocol

**LEC** local exchange carrier

**Location Server** A SIP redirect or proxy server uses a location server to get information about a caller's location. Location services are offered by location servers.

---

## M

**MWI** message waiting indication

**μ-law** North American companding standard used in conversion between analog and digital signals in PCM systems. Similar to the European a-law. See also a-law and companding.

---

## N

**NAT** Network Address Translation. Mechanism for reducing the need for globally unique IP addresses. NAT allows an organization with addresses that are not globally unique to connect to the Internet by translating those addresses into globally routable address spaces. Also known as Network Address Translator.

**NSE packets** Real-Time Transport Protocol (RTP) digit events are encoded using the Named Signaling Event (NSE) format specified in RFC 2833, Section 3.0.

**NAT Server** Network Address Translation. an Internet standard that enables a local-area network (LAN) to use one set of IP addresses for internal traffic and a second set of addresses for external traffic.

**NTP** Network Time Protocol. Protocol built on top of TCP that assures accurate local time-keeping with reference to radio and atomic clocks located on the Internet. This protocol is capable of synchronizing distributed clocks within milliseconds over long time periods.

---

## P

**POTS** Plain old phone service. Basic phone service supplying standard single-line phones, phone lines, and access to the PSTN.



**Proxy Server** An intermediary program that acts as both a server and a client for the purpose of making requests on behalf of other clients. Requests are serviced internally or by passing them on, possibly after translation, to other servers. A proxy interprets, and, if necessary, rewrites a request message before forwarding it.

**PSTN** Public switched phone network

---

## Q

**QoS** Quality of Service. The capability of a network to provide better service to selected network traffic over various technologies, including Frame Relay, Asynchronous Transfer Mode (ATM), Ethernet and 802.1 networks, SONET, and IP-routed networks that may use any or all of these underlying technologies. The primary goal of QoS is to provide priority including dedicated bandwidth, controlled jitter and latency (required by some real-time and interactive traffic), and improved loss characteristics.

---

## R

**Redirect Server** A redirect server is a server that accepts a SIP request, maps the address into zero or more new addresses, and returns these addresses to the client. It does not initiate its own SIP request nor accept calls.

**Registrar Server** A registrar server is a server that accepts Register requests. A registrar is typically co-located with a proxy or redirect server and may offer location services.

**router** Network layer device that uses one or more metrics to determine the optimal path along which network traffic should be forwarded. Routers forward packets from one network to another based on network layer information. Occasionally called a gateway (although this definition of gateway is becoming increasingly outdated). Compare with gateway.

**RTP** Real-Time Transport Protocol. One of the IPv6 protocols. RTP is designed to provide end-to-end network transport functions for applications transmitting real-time data, such as audio, video, or simulation data, over multicast or unicast network services. RTP provides services such as payload type identification, sequence numbering, timestamping, and delivery monitoring to real-time applications.

---

## S

**SDP** Session Definition Protocol. An IETF protocol for the definition of Multimedia Services. SDP messages can be part of SGCP and MGCP messages.

**SIP** Session Initiation Protocol. Protocol developed by the IETF MMUSIC Working Group as an alternative to H.323. SIP features are compliant with IETF RFC 2543, published in March 1999. SIP equips platforms to signal the setup of voice and multimedia calls over IP networks.

**SIP endpoint** A terminal or gateway that acts as a source or sink of Session Initiation Protocol (SIP) voice data. An endpoint can call or be called, and it generates or terminates the information stream.

**SLIC** Subscriber Line Interface Circuit. An integrated circuit (IC) providing central office-like phone interface functionality.

**SOHO** Small office, home office. Networking solutions and access technologies for offices that are not directly connected to large corporate networks.

---

## T

**T.38** T.38 is an ITU recommendation for allowing transmission of fax over IP networks in real time.

**TCP** Transmission Control Protocol. Connection-oriented transport layer protocol that provides reliable full-duplex data transmission. TCP is part of the TCP/IP protocol stack.

**TFTP** Trivial File Transfer Protocol. Simplified version of FTP that allows files to be transferred from one computer to another over a network, usually without the use of client authentication (for example, username and password).

**TN power systems** A TN power system is a power distribution system with one point connected directly to earth (ground). The exposed conductive parts of the installation are connected to that point by protective earth conductors.

**TOS** Type of service. See CoS.

---

## U

**UAC** User agent client. A client application that initiates the SIP request.

**UAS** User agent server (or user agent). A server application that contacts the user when a SIP request is received, and then returns a response on behalf of the user. The response accepts, rejects, or redirects the request.

**UDP** User Datagram Protocol. Connectionless transport layer protocol in the TCP/IP protocol stack. UDP is a simple protocol that exchanges datagrams without acknowledgments or guaranteed delivery, requiring that error processing and retransmission be handled by other protocols. UDP is defined in RFC 768.

**user agent** See UAS.

---

## V

**VAD** Voice activity detection. When enabled on a voice port or a dial peer, silence is not transmitted over the network, only audible speech. When VAD is enabled, the sound quality is slightly degraded but the connection monopolizes much less bandwidth.

**voice packet gateway**

Gateway platforms that enable Internet telephony service providers to offer residential and business-class services for Internet telephony.

**VoIP**

Voice over IP. The capability to carry normal telephony-style voice over an IP-based Internet with POTS-like functionality, reliability, and voice quality. VoIP enables a router to carry voice traffic (for example, phone calls and faxes) over an IP network. In VoIP, the DSP segments the voice signal into frames, which then are coupled in groups of two and stored in voice packets. VoIP is a blanket term, which generally refers to Cisco's standard-based (for example H.323) approach to IP voice traffic.

---

**X****XML**

eXtensible Markup Language. Designed to enable the use of SGML on the World-Wide Web. XML allow you to define your own customized markup language.





## INDEX

---

### Symbols

.cnf.xml configuration file [2-3](#)

---

### A

AC adapter, connecting [3-3](#)

adding

ATA 187 manually [2-6](#)

ATA 187 using auto-registration [2-6](#)

Cisco Unified IP Phones using BAT [2-7](#)

users to Cisco Unified Communications Manager [4-6](#)

Advance Adhoc Conference service parameter [4-2](#)

ATA 187

adding manually to Cisco Unified Communications Manager [2-6](#)

adding to Cisco Unified Communications Manager [2-5](#)

cleaning [6-10](#)

registering [2-5](#)

registering with Cisco Unified Communications Manager [2-6](#)

troubleshooting and maintenance [6-1](#)

Audible message waiting indicator [4-1](#)

auto-registration

using [2-6](#)

---

### B

BAT (Bulk Administration Tool) [2-7](#)

---

### C

caller ID [4-2, 7-2](#)

call forward

all calls [4-2](#)

call forwarding

in Sweden [7-7](#)

in United States [7-7](#)

types [7-6](#)

call pickup [4-2](#)

call waiting [4-2](#)

in Sweden [7-6](#)

in United States [7-6](#)

call-waiting caller ID [7-2](#)

charge [4-1](#)

Cisco Unified Communications Manager

adding phone to database of [2-5](#)

interactions with [2-2](#)

verifying settings [6-3](#)

Cisco Unified Communications Manager Administration

adding telephony features using [4-1](#)

Cisco Unified IP Phone

power sources [2-2](#)

registering with Cisco Unified Communications Manager [2-7](#)

cleaning

cleaning the ATA 187 [6-10](#)

cleaning the ATA 187 [6-10](#)

conference [4-2](#)

conference call

in Sweden [7-6](#)

in United States [7-5](#)

conference joining [4-2](#)

configuration file

.cnf.xml [2-3](#)

creating [6-3](#)

overview [2-3](#)

secure [2-3](#)

configuring

user features [4-6](#)

connecting

to AC adapter [3-3](#)

to the network [3-3](#)

CTL file

requesting [2-4](#)

---

## D

daisy chaining [6-7](#)

DHCP

troubleshooting [6-5](#)

DHCP IP address [6-9](#)

directory numbers, assigning manually [2-6](#)

direct transfer [4-3](#)

DNS server

troubleshooting [6-6](#)

verifying settings [6-3](#)

---

## E

electrical specifications [A-2](#)

environmental specifications [A-2](#)

---

## F

fax pass-through mode [5-1](#)

fax services [5-1](#)

forced authorization codes [4-3](#)

FXS ports [1-5](#)

---

## G

group call pickup [4-3](#)

---

## H

hold [4-3](#)

---

## I

installing

preparing [2-5](#)

---

## L

Lightweight Directory Access Protocol (LDAP) [1-3](#)

---

## M

meet-me conference [4-3](#)

message waiting [4-3](#)

methods supported [1-8](#)

music-on-hold [4-3](#)

---

## N

network connectivity, checking [6-2](#)

network outages, identifying [6-5](#)

Network port [1-5](#)

network port

connecting to [3-3](#)

---

## P

physical connection, verifying [6-5](#)

physical interfaces [A-2](#)

physical specifications [A-1](#)

power

providing to the ATA 187 [2-2](#)

power source

causing phone to restart [6-7](#)

description [2-2](#)

external power 2-2  
 privacy 4-4  
 proxy server 1-4

## R

redial 4-4  
 redirect server 1-4  
 registrar server 1-4  
 resetting  
     continuously 6-4, 6-5  
 ringing characteristics A-3

## S

security  
     secure configuration file 2-3  
 services  
     sip 1-7  
     supplemental 1-9  
 shared line 4-4  
 SIP 1-2  
     clients 1-4  
     servers 1-4  
 software specifications (all protocols) A-3  
 speed dialing 4-1, 4-4  
 standard (ad hoc) conference 4-2  
 startup problems 6-1  
 startup process  
     contacting Cisco Unified Communications Manager 2-5  
     loading stored ATA 187 image 2-4  
     obtaining IP address 2-4  
     obtaining power 2-4  
     requesting configuration file 2-5  
     requesting CTL file 2-4  
     understanding 2-4  
 supplementary services  
     common 7-1

## T

T.38 fax relay mode 5-1  
 telephony features  
     Audible message waiting indicator 4-1  
     caller ID 4-2  
     call forward 4-2  
     call pickup 4-2  
     call waiting 4-2  
     cbarge 4-1  
     conference 4-2  
     direct transfer 4-3  
     forced authorization codes 4-3  
     group call pickup 4-3  
     hold 4-3  
     meet-me conference 4-3  
     music-on-hold 4-3  
     privacy 4-4  
     redial 4-4  
     shared line 4-4  
     speed dialing 4-4  
     time zone update 4-4  
     voice messaging system 4-4  
 TFTP  
     troubleshooting 6-2  
 time zone update 4-4  
 TLS 2-3  
 troubleshooting  
     ATA 187 6-1  
     Cisco Unified Communications Manager settings 6-3  
     DHCP 6-5  
     DNS 6-6  
     DNS settings 6-3  
     network connectivity 6-2  
     network outages 6-5  
     physical connection 6-5  
     services on Cisco Unified Communications Manager 6-3  
     TFTP settings 6-2

VLAN configuration [6-6](#)

---

## U

User agent client (UAC) [1-3](#)

User agent server (UAS) [1-3](#)

users

adding to Cisco Unified Communications  
Manager [4-6](#)

using phone templates to add phones [2-7](#)

---

## V

VLAN

verifying [6-6](#)

voice messaging system [4-4](#)

---

## W

warnings

installation [3-2](#)

lightning activity [3-2](#)

main disconnecting device [3-2](#)

product disposal [3-2](#)